

UNCONVENTIONAL SOFAS

NIERI

NIERI

The logo consists of the word "NIERI" in a bold, black, serif font. Below the text is a horizontal bar divided into three equal segments of green, white, and red, representing the colors of the Italian flag.

NIERI is a trademark of ROMA IMPERIALE srl

via Bologna, 13 - 51039 - Quarrata - PT- ITALY
tel: 0039 0573 7733 - fax: 0039 0573 739710

www.romaimperiale.net
info@nieri.it



NIERI
MADE IN ITALY

NIERI
P R O D U C E
VERO, ORIGINALE
PRODOTTO ITALIANO
CERTIFICATO

WARRANTY



Made in Italy 100% certificate

FACTORY REGISTER N° IT01.IT/661.102.M

MODERN COLLECTION

- 8 _Infinity
- 10 _Kosmos
- 12 _Metropolitan
- 16 _Marathon
- 20 _Alison
- 24 _Espace
- 28 _Kespace
- 30 _Marika
- 32 _Compass
- 34 _Louis
- 36 _Wes
- 38 _Galaxy
- 40 _Matisse
- 46 _Camaleon
- 48 _Liz
- 50 _Avatar
- 52 _Alifax
- 54 _Tom

CLASSICAL COLLECTION

- 58 _Canaletto
- 60 _Fitzgerald
- 64 _Romeo
- 66 _Planet
- 68 _Corniche
- 72 _Bentley
- 76 _Geisha
- 78 _Zen
- 80 _Monaco
- 82 _Orchidea
- 84 _Morgan
- 86 _Chester
- 88 _Manchester
- 90 _New York
- 92 _Pompei
- 94 _Incas
- 96 _Palatino
- 98 _Farfalla
- 100 _Victoria
- 102 _Elena

CHAIRS 104

SOFABEDS 114

FOOTSTOOLS 122

TABLES 128

DECORS 132



MODERN COLLECTION



MODERN
COLLECTION

_Infinity

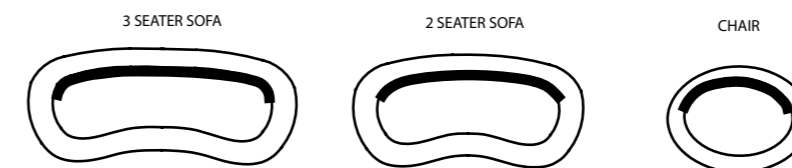

CODES	ELEMENTS	H	L	D	V	W
INFB25	INFINITY ARMCHAIR	82	103	103	0,8	33
INFB01	INFINITY 2 SEATER	80	205	110	1,8	61
INFC01	INFINITY 3 SEATER	80	235	110	2	72

- * Back seat cushions are included in the price and can be chosen in all coverings of our collection.
- * The 3 seater includes 3 back cushions 60x50 cm in a chosen covering of our collection
- * The 2 seater includes 2 back cushions 60x50 cm in a chosen covering of our collection
- * The Armchair doesn't include any back cushions but we recommend choosing one of our 40x40 décor cushion covering of our collection
- * The back part of the each piece is open, and the back cushions are sustained by a padded structure made of wood. We recommend never to seat on the back frame.
- * Different combination of coverings or different sizes are not previewed in our system. Special requests will be considered a "non standard product" and a 10% surcharge will be applied.

MODERN
COLLECTION

_Kosmos

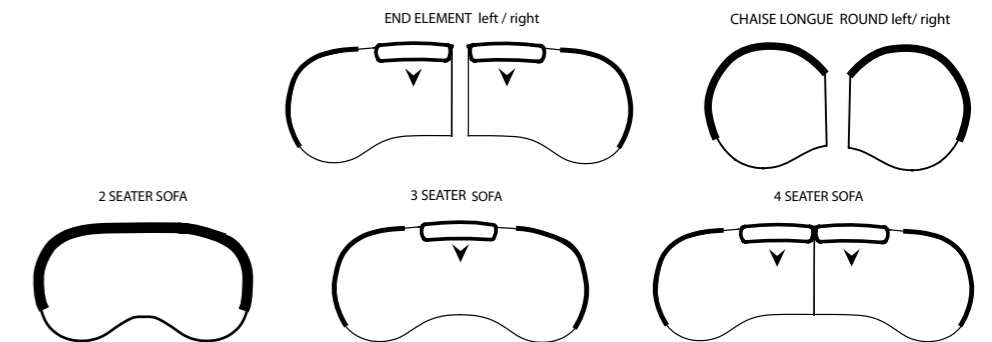

CODES	ELEMENTS	H	L	D	V	W
KOSB60	KOSMOS 2 SEATER	84	176	127	1,87	60
KOSC60	KOSMOS 3 SEATER	84	235	143	2,8	84
KOSD40	KOSMOS 4 SEATER	84	304	143	3	114
KOSB38	KOSMOS END ELEMENT 2S RIGHT	84	152	143	1,9	58
KOSB39	KOSMOS END ELEMENT 2S LEFT	84	152	143	1,9	58
KOSE46	KOSMOS CHAISE LONGUE ROUND RIGHT	84	139	168	1,96	58
KOSE47	KOSMOS CHAISE LONGUE ROUND LEFT	84	139	168	1,96	58

- * Only the central backseats with lumbar support have an adjustable mechanism. For moving the back seats back and forth slip your hands underneath the back cushions and pull up in vertical and then horizontal movement. Do not push or pull without lifting the backseat at the same time.
- * Rubber profile painted in metal color.
- * The 2 end elements 2 seater right and left and includes 2 back cushions 52x62 cm and 1 lumbar support 55X30 each in a chosen covering of our collection.
- * The 3 seater includes 2 back cushions 55x50 cm and 1 lumbar support 55X30 in a chosen covering of our collection
- * The 4 seater it's a combination of 2 end elements 2 seater right and left and includes 4 back cushions 52x62 cm and 2 lumbar support 55X30 in a chosen covering of our collection.
- * The Round Seat includes 2 back cushions 55x50 cm and 1 décor cushion 40x40 cm and 1 lumbar support 55X30 in a chosen covering of our collection.
- * For extra décor cushions or lumbar support please see cushions price list.
- * Different combination of coverings or different sizes are not previewed in our system. Special requests will be considered a "non standard product" and a 10% surcharge will be applied.



MODERN
COLLECTION

_Metropolitan





CODES	ELEMENTS	H	L	D	V	W
METD01	METROPOLITAN FOOTSTOOL	41	70	60	0,1	15
METB01	METROPOLITAN 2 SEATER	68	200	105	2	77
METC01	METROPOLITAN 3 SEATER	68	230	105	2,2	86
METE06	METROPOLITAN CHAISE LONGUE RIGHT	68	128	164	1,42	54
METE07	METROPOLITAN CHAISE LONGUE LEFT	68	128	164	1,42	54
METF24	METROPOLITAN BACK CUSHIONS		62	52	0,1	
METF03	DECOR CUSHION		35	35		
META04	METROPOLITAN CENTRAL ELEMENT	69	84	102	0,6	30
METF12	METROPOLITAN HEAD REST	34	78			
META02	METROPOLITAN END ELEMENT 1 SEAT RIGHT	69	126	105	1	47
META03	METROPOLITAN END ELEMENT 1 SEAT LEFT	69	126	105	1	47
METB02	METROPOLITAN END ELEMENT 2 SEATER RIGHT	68	170	106	1,2	49
METB03	METROPOLITAN END ELEMENT 2 SEATER LEFT	68	170	106	1,2	49
METC02	METROPOLITAN END ELEMENT 3 SEATER RIGHT	68	200	106	1,3	63
METC03	METROPOLITAN END ELEMENT 3 SEATER LEFT	68	200	106	1,3	63

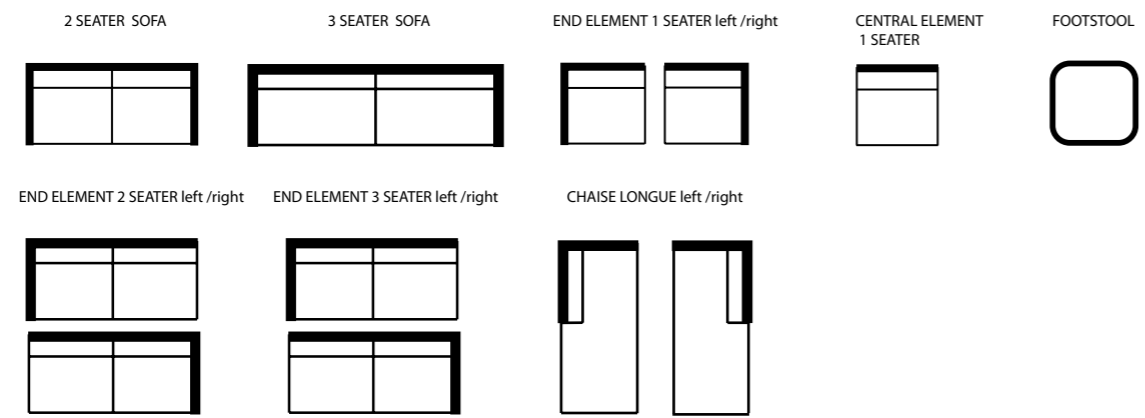

- * Contrast thread stitching when base in leather and contrast stitching when base in fabric.
- * Headrests and decor cushions needs to be ordered separately.
- * **Central element can be used as armchair and viceversa.**
- * Different combination of coverings or different sizes are not previewed in our system. Special requests will be considered a " non standard product" and a 10% surcharge will be applied.

MODERN
COLLECTION

_Marathon

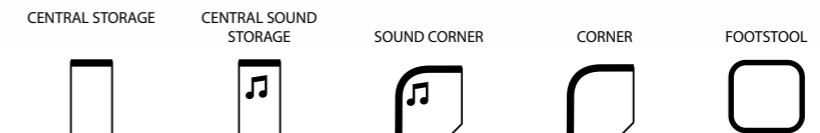
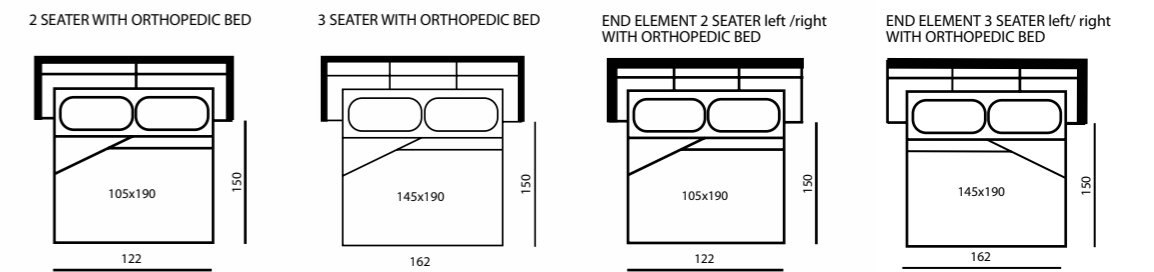
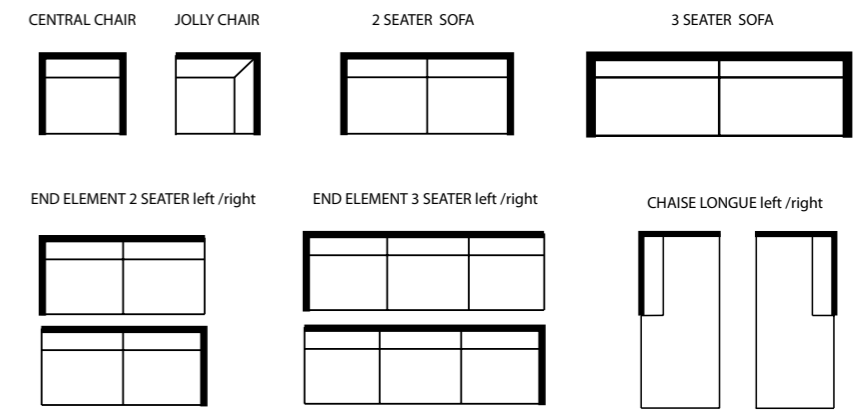

CODES	ELEMENTS	H	L	D	V	W
MRHB01	MARATHON 2 SEATER	84	191	106	1,95	67
MRHB08	MARATHON 2 SEATER WITH ORTHOPEDIC BED	84	191	106	2	87
MRHC01	MARATHON 3 SEATER	84	240	106	2,5	73
MRHC08	MARATHON 3 SEATER WITH ORTHOPEDIC BED	84	240	106	2,5	93
MRHE06	MARATHON CHAISE LONGUE RIGHT	84	120	174	1,8	49
MRHE07	MARATHON CHAISE LONGUE LEFT	84	120	174	1,8	49
MRHA04	MARATHON CENTRAL CHAIR WITH ARMRESTS	84	103	103	1	35
MRHA31	MARATHON JOLLY ELEMENT	84	103	103	1	31
MRHE21	MARATHON SOUND CORNER	56	122	122	1	50
MRHE01	MARATHON CORNER	56	122	122	1	50
MRHF24	MARATHON BACK CUSHION JOLLY/CENTRAL		60	50	0,01	5
MRHF08	MARATHON SMALL BACK CUSHION		40	40	0,01	3
MRHE25	MARATHON MERIDIENNE	84	103	173	1,5	49
MRHD07	MARATHON FOOTSTOOL	38	103	103	0,5	23
MRHA34	MARATHON STORAGE	72	48	110	0,3	
MRHA35	MARATHON STORAGE SOUND	72	48	110	0,3	
MRHA02	MARATHON END ELEMENT 1 SEATER RIGHT	84	100	106	0,6	30
MRHA03	MARATHON END ELEMENT 1 SEATER LEFT	84	100	106	0,6	30
MRHA64	MARATHON CENTRAL ELEMENT 1 SEATER					
MRHB02	MARATHON END ELEMENT 2 SEATER RIGHT	84	160	106	1,5	65
MRHB03	MARATHON END ELEMENT 2 SEATER LEFT	84	160	106	1,5	65
MRHB24	MARATHON END ELEMENT 2 SEATER RIGHT WITH BED	84	160	106	1,5	85
MRHB25	MARATHON END ELEMENT 2 SEATER LEFT WITH BED	84	160	106	1,5	85
MRHC02	MARATHON END ELEMENT 3 SEATER RIGHT	84	207	106	1,9	69
MRHC03	MARATHON END ELEMENT 3 SEATER LEFT	84	207	106	1,9	69
MRHC24	MARATHON END ELEMENT 3 SEATER WITH ORTHOPEDIC BED RIGHT	84	207	106	1,9	
MRHC25	MARATHON END ELEMENT 3 SEATER WITH ORTHOPEDIC BED LEFT	84	207	106	1,9	



* Back seat cushions are included in the price and can be chosen in all coverings of our collection.

BACKREST CUSHIONS DIMENTIONS:

- For 3 seater + End. elem. 3s + chaise longue = 90x50 cm
- For Jolly Element = 60x50 cm
- For End element 2 seater , central element, 2 seater = 70x50 cm
- Decor Cushions: Suitable for all elements = 40x40 cm

* The upper seat cushions is removable and changeable but only as a unique piece with covering and foam

* The back part of the sets is open, and the back cushions are sustained by a padded structure and by metal bars. We recommend never to seat on the back frame.

* The bed version has a French bed mechanism with orthopedic mattress easy to pull out by removing the upper seat cushions.

* Different combination of coverings or different sizes are not previewed in our system. Special requests will be considered a "non standard product" and a 10% surcharge will be applied.

MODERN
COLLECTION

_Alison





CODES	ELEMENTS	H	L	D	V	W
AINA01	ALISON ARMCHAIR	72	82	103	0,7	25
AINA50	ALISON LOVE SEAT	70	121	174	1,47	52
AINB01	ALISON 2 SEATER	70	200	104	1,5	60
AINB63	ALISON END ELEMENT 2 SEATER LEFT	70	140	104	1,3	53
AINB62	ALISON END ELEMENT 2 SEATER RIGHT	70	140	104	1,3	53
AINC01	ALISON 3 SEATER	70	236	104	1,8	67
AINC63	ALISON END ELEMENT 3 SEATER LEFT	70	184	104	1,5	57
AINC62	ALISON END ELEMENT 3 SEATER RIGHT	70	184	104	1,5	57
AINE07	ALISON CHAISE LONGUE LEFT	70	97	175	1,2	46
AINE06	ALISON CHAISE LONGUE RIGHT	70	97	175	1,2	46
AINE21	ALISON CORNER SOUND	63	115	150	1,1	58
AINE01	ALISON CORNER	63	115	150	1,1	48
AIND01	ALISON FOOTSTOOL	40	60	60	0,2	13

* For this kind of sofa we recommend using only Extra quality leather and strong non patterned fabric.
 * Combined version leather /fabric is not available.
 * Different combination of coverings or different sizes are not previewed in our system. Special requests will be considered a "non standard product" and a 10% surcharge will be applied.

MODERN
COLLECTION

_Espace



CODES	ELEMENTS	H	L	D	V	W
EPCA01	ESPACE ARMCHAIR	74	84	90	0,6	34
EPCB25	ESPACE ROUND SEAT XXL	80	150	154	1,9	80
EPCB26	ESPACE ROUND SEAT G (TURNING)	80	150	154	1,9	86
EPCB10	ESPACE SOFA 175	78	175	110	1,5	
EPCB01	ESPACE 2 SEATER SOFA	78	211	110	1,9	70
EPCC01	ESPACE 3 SEATER SOFA	78	241	110	2,2	79
EPCD03	ESPACE DROP SHADED FOOTSTOOL RIGHT	42	130	68	0,3	23,5
EPCD04	ESPACE DROP SHADED FOOTSTOOL LEFT	42	130	68	0,3	23,5
EPCD27	ESPACE SOFA/FOOTSTOOL	45	160	73	0,6	24
EPCE06	ESPACE CHAISE LONGUE RIGHT	80	197	122	1,92	67,5
EPCE07	ESPACE CHAISE LONGUE LEFT	80	197	122	1,92	67,5
EPCF01	ESPACE BACK CUSHION	50	60	50	0,01	2
EPCD07	ESPACE FOOTSTOOL MAX	43	98	101	1	40
EPC056	ESPACE OVAL TABLE WITH TOP GLASS	37	165	98	0,6	58

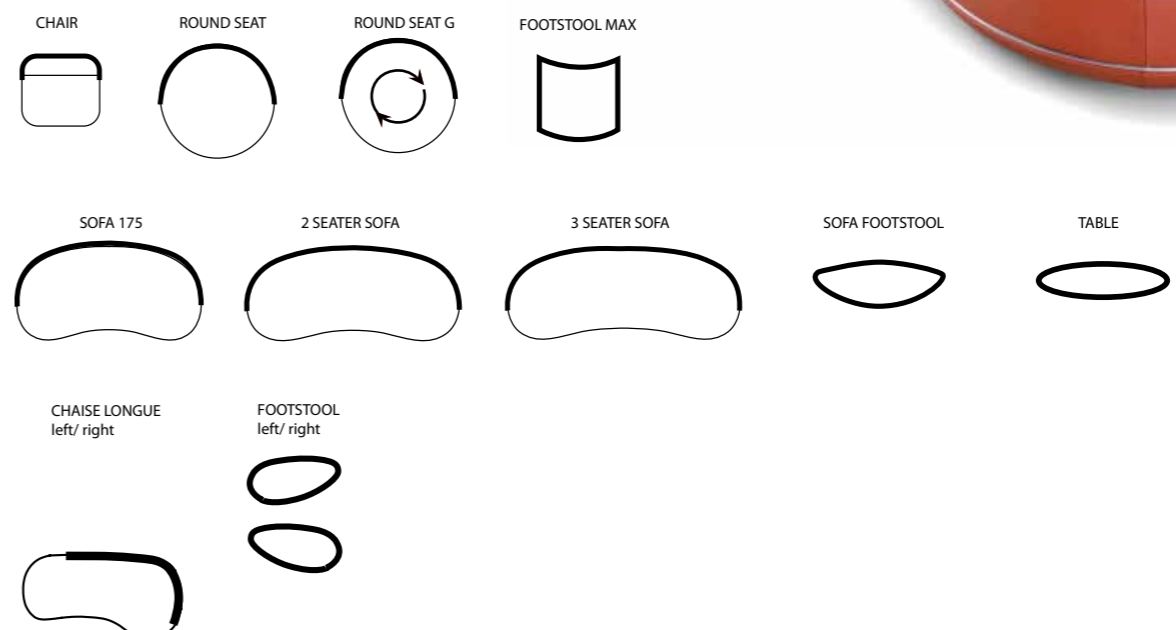

- * An extra 10% on the price has to be added by any non standard modification of the external sight.
- * Light padding piece of furniture (please see sales conditions).
Rubber profile painted in metal color.
- * The 3 seater includes 4 back cushions 52x62 cm in a chosen covering of our collection
- * The 2 seater includes 4 back cushions 52x62 cm in a chosen covering of our collection
- * The Round Seat includes 4 back cushions 52x62 cm in a chosen covering of our collection
- * Round table upper glass in smoked black color (not to be chosen)
- * Different combination of coverings or different sizes are not previewed in our system. Special requests will be considered a "non standard product" and a 10% surcharge will be applied.



_Kespace



END ELEMENT 3 SEATER
left/right

END ELEMENT 2 SEATER
left/right

END ELEMENT 1 SEATER
left/right

ROUND SEAT

SOFA FOOTSTOOL

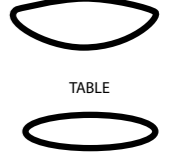
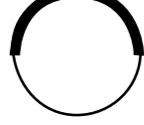
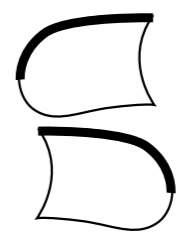
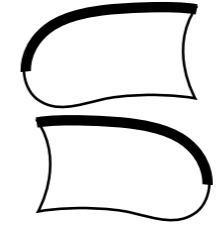

CODES	ELEMENTS	H	L	D	V	W
KESA02	END ELEMENT 1 SEATER RIGHT	78	115	110	0.9	
KESA03	END ELEMENT 1 SEATER LEFT	78	115	110	0.9	
KESB02	END ELEMENT 2 SEATER RIGHT	78	170	110	1,5	50
KESB03	END ELEMENT 2 SEATER LEFT	78	170	110	1,5	50
KESC02	END ELEMENT 3 SEATER RIGHT	78	200	110	1,8	57
KESC03	END ELEMENT 3 SEATER LEFT	78	200	110	1,8	57
KESF01	BACK CUSHION	50	60		0,01	2
KESD27	SOFA/FOOTSTOOL	45	150	135	0,6	24
EPC056	OVAL TABLE WITH TOP GLASS	37	165	98	0,6	58

- * Rubber profile painted in metal color.
- * The end element 2 seater includes 3 back cushions 52x62 cm in a chosen covering of our collection
- * The end element 3 seater includes 4 back cushions 52x62 cm in a chosen covering of our collection
- * The Round Seat includes 4 back cushions 52x62 cm in a chosen covering of our collection,
- * Different combination of coverings or different sizes are not previewed in our system. Special requests will be considered a "non standard product" and a 10% surcharge will be applied.

MODERN
COLLECTION

_Marika

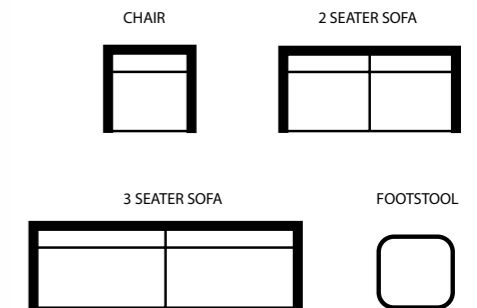

CODES	ELEMENTS	H	L	D	V	W
MTEA01	MARIKA ARMCHAIR	96	102	110	1	35
MTEA05	MARIKA ARMCHAIR WITH ELECTRIC RECLINER	96	102	110	1	45
MRKB60	MARIKA 2 SEATER HEAD REST	96	200	110	1,6	90
MRKB80	MARIKA 2 SEATER WITH 2 RECLINER	96	200	110	1,6	100
MRKB82	MARIKA 2 SEATER RIGHT WITH RECLINER	98	200	110	1,6	80
MRKB83	MARIKA 2 SEATER LEFT WITH RECLINER	96	200	110	1,6	80
MRKC60	MARIKA 3 SEATER HEADREST	96	230	110	1,92	108
MRKC80	MARIKA 3 SEATER WITH 2 RECLINER	96	230	110	1,92	120
MRKC82	MARIKA 3 SEATER RIGHT WITH RECLINER	96	230	110	1,92	108
MRKC83	MARIKA 3 SEATER LEFT WITH RECLINER	96	230	110	1,92	108
MTED07	M2 FOOTSTOOL 70X70	40	70	70	0,2	12,5

* Adjustable headrests are a characteristic of each piece, with or without recliner. In order not to break the internal headrests mechanism we suggest to lift up the headrest adjust it in one of the 3 possible positions and to bring it back, push it forward till you feel the mechanism soften and bring it back in horizontal position.

* Different combination of coverings or different sizes are not previewed in our system. Special requests will be considered a "non standard product" and a 10% surcharge will be applied.

MODERN
COLLECTION

_Compass

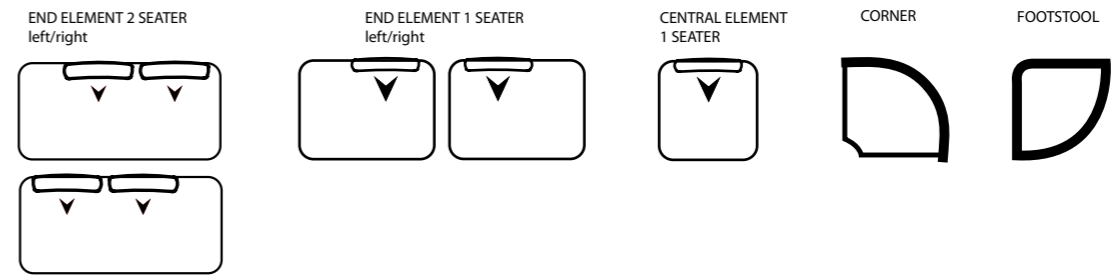

CODES	ELEMENTS	H	L	D	V	W
COMA38	COMPASS END ELEMENT 123 CM RIGHT	83	123	116	1,1	34
COMB38	COMPASS END ELEMENT 193 CM RIGHT	83	193	116	2	58
COME01	COMPASS CORNER	83	174	125	1,8	47
COMD01	COMPASS FOOTSTOOL	41	115	84	0,4	19
COMA39	COMPASS END ELEMENT 123 CM LEFT	83	123	116	1,1	34
COMB39	COMPASS END ELEMENT 193 CM LEFT	83	193	116	2	58
COMA04	COMPASS CENTRAL ELEMENT	83	70	116	0,7	45

- * Movable metal back and forth mechanism for back seats and armrests. Corner back seat fixed.
- * For moving the back seats back and forth slip your hands underneath the back cushions and pull up in vertical and then horizontal movement.
- * Lumbar support pillows included and not removable. They are stitched to the back seat.
- * Rubber profile painted in metal color.
- * Different combination of coverings or different sizes are not previewed in our system. Special requests will be considered a "non standard product" and a 10% surcharge will be applied.

MODERN COLLECTION

_Louis

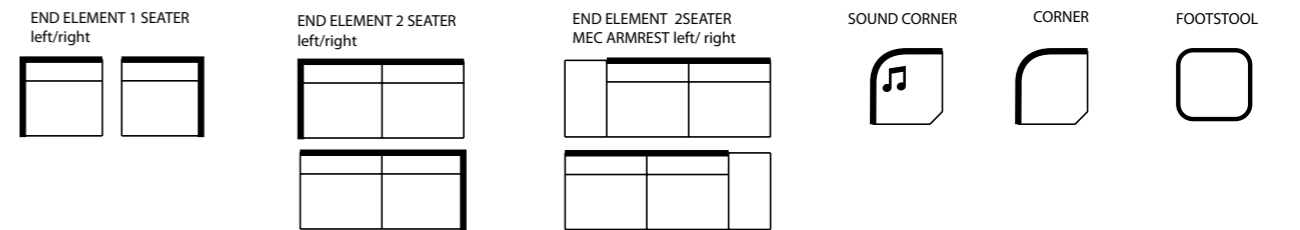

CODES	ELEMENTS	H	L	D	V	W
LOUE62	LOUIS CHAISE END ELEMENT 2 SEATER MEC ARMREST RIGHT	72	190	110	1,5	70
LOUE63	LOUIS CHAISE END ELEMENT 2 SEATER MEC ARMREST LEFT	72	190	110	1,5	70
LOUB63	LOUIS END ELEMENT 2 SEATER LEFT 2 HEADRESTS	72	170	110	1,4	60
LOUB62	LOUIS END ELEMENT 2 SEATER RIGHT 2 HEADRESTS	72	170	110	1,4	60
LOUF22	LOUIS BACK CUSHIONS		57	47		1
LOUE01	LOUIS CORNER	56	122	161	1,1	48
LOUE21	LOUIS SOUND CORNER	56	122	161	1,1	48
LOUD01	LOUIS FOOTSTOOL	37	90	60	0,2	13

- * Adjustable headrests are a characteristic of each piece, with or without recliner. In order not to break the internal headrests mechanism we suggest to lift up the headrest adjust it in one of the 3 possible positions and to bring it back, push it forward till you feel the mechanism soften and bring it back in horizontal position.
- * Loose pillows are not included in the composition. In case you order a Corner Element we recommend choosing also the corresponding back seat loose pillows 40x40 cm.
- * Corner Sound or Sound Storage devices can be used to reproduce MP3, iPhones, iPods etc.
- * Different combination of coverings or different sizes are not previewed in our system. Special requests will be considered a "non standard product" and a 10% surcharge will be applied.

MODERN
COLLECTION

_Wes

CODES	ELEMENTS	H	L	D	V	W
WESA01	WES ARMCHAIR	74	84	90	0,6	34
WESB03	WES END ELEMENT LEFT	78	150	110	1,4	62
WESB02	WES END ELEMENT RIGHT	78	150	110	1,4	62
WESE07	WES CHAISE LONGUE LEFT	78	130	192	2	52
WESE06	WES CHAISE LONGUE RIGHT	78	130 <td 192	2	52	
WESD03	WES FOOTSTOOL FOR CHAISE LONGUE RIGHT	42	126	76	0,6	26
WESD04	WES FOOTSTOOL FOR CHAISE LONGUE LEFT	42	126	76	0,6	26

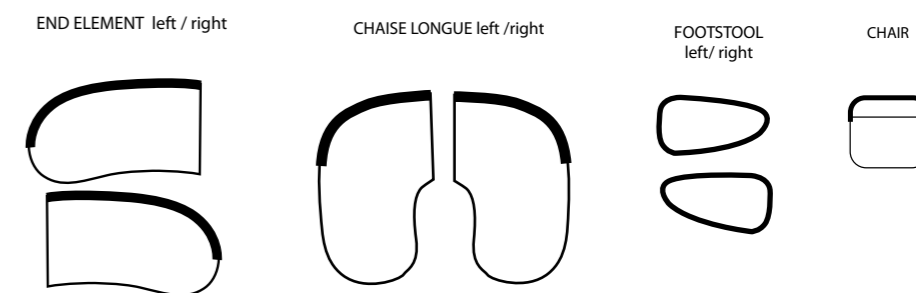

- * For each chaise longue version a corresponding right or left footstool must be matched.
- * Rubber profile painted in metal color.
- * The set includes 5 back cushions 52x62 cm in a chosen covering of our collection.
- * Different combination of coverings or different sizes are not previewed in our system. Special requests will be considered a "non standard product" and a 10% surcharge will be applied.

MODERN
COLLECTION

_Galaxy



END ELEMENT 3 SEATER left/right

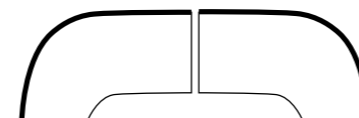

CENTRAL FOOTSTOOL



LATERAL FOOTSTOOL
left/right



CODES	ELEMENTS	H	L	D	V	W
GALC03	GALAXY 3 SEATER LEFT WITH HEADREST	85	155	135	1,8	49
GALC02	GALAXY 3 SEATER RIGHT WITH HEADREST	85	155	135	1,8	49
GALD04	GALAXY FOOTSTOOL LEFT	42	145	55	0,4	20
GALD03	GALAXY FOOTSTOOL RIGHT	42	145	55	0,4	20
GALD19	GALAXY CENTRAL FOOTSTOOL	42	165	42	0,3	20

* Movable Headrest is only in the 2 central backseats.

* The composition can be sold also separately.

* Different combination of coverings or different sizes are not previewed in our system. Special requests will be considered a "non standard product" and a 10% surcharge will be applied.

MODERN
COLLECTION

_Matisse



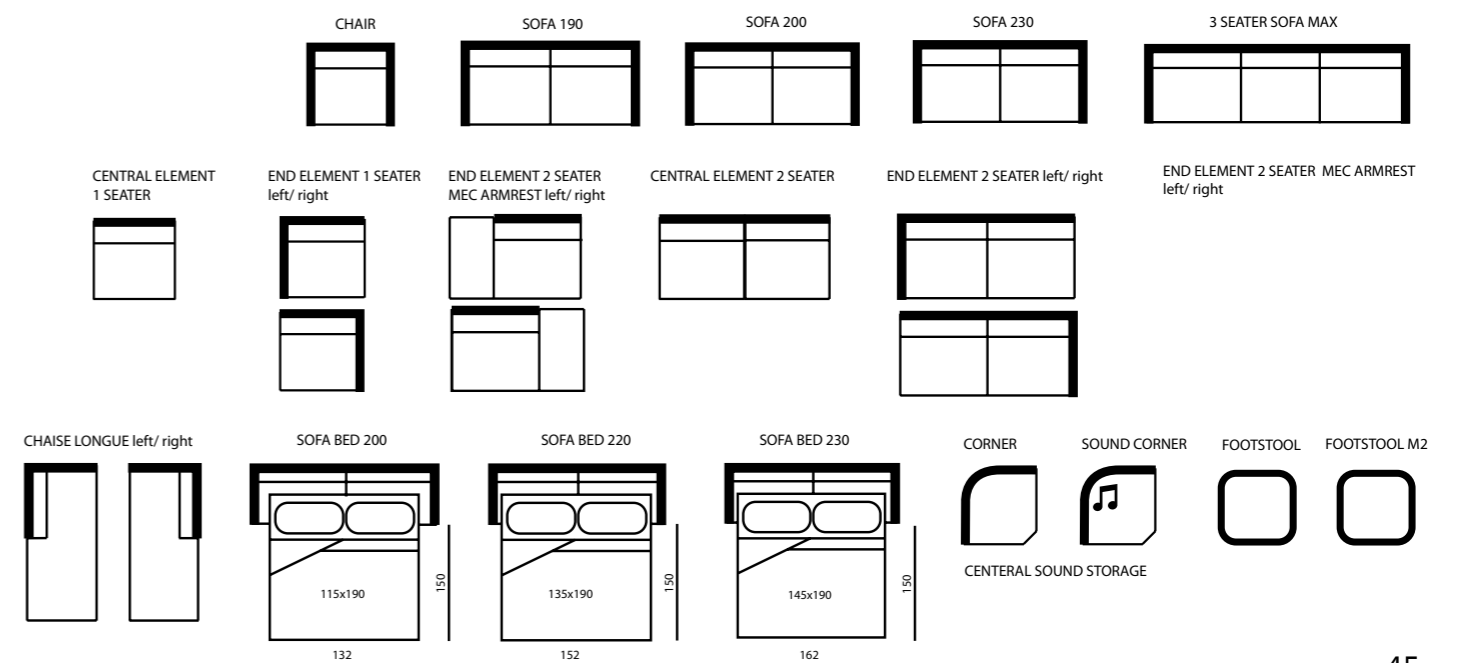

CODES	ELEMENTS	H	L	D	V	W
MTEA01	MATISSE ARMCHAIR	72/96	102	110	1	35
MTEA05	MATISSE ARMCHAIR WITH ELECTRIC RECLINER	72/96	102	110	1	45
MTEB60	MATISSE SOFA 200	72/96	200	110	1.6	70
MTEC60	MATISSE SOFA 230	72/96	230	110	1.8	
MTEB05	MATISSE SOFA 200 WITH 1 ELECTRICAL RECLINER RIGHT	72/96	200	110	1.6	80
MTEB06	MATISSE SOFA 200 WITH 1 ELECTRICAL RECLINER LEFT	72/96	200	110	1.6	80
MTEB80	MATISSE SOFA 200 WITH 2 ELECTRICAL RECLINERS	72/96	200	110	1.6	90
MTEC67	MATISSE 3 MAX 260	72/96	260	110	2,8	
MTEC77	MATISSE 3 MAX 260 WITH 2 RECLINERS	72/96	260	110	2,8	
MTEC80	MATISSE 3 MAX 260 CM WITH 3 RECLINERS	72/96	260	110	2,8	
MTEC05	MATISSE 3 MAX 260 CM WITH RECLINER RIGHT	72/96	260	110	2,8	90
MTEC06	MATISSE 3 MAX 260 CM WITH RECLINER LEFT	72/96	260	110	2,8	90
MTEB62	MATISSE END ELEM. 2 SEATER RIGHT	72/96	170	110	1,4	60
MTEB63	MATISSE END ELEM. 2 SEATER LEFT	72/96	170	110	1,4	60
MTEB16	MATISSE END ELEM. 2 SEATER RIGHT WITH 1 RECLINER	72/96	170	110	1,4	88
MTEB17	MATISSE END ELEM. 2 SEATER LEFT WITH 1 RECLINER	72/96	170	110	1,4	88
MTEB18	MATISSE END ELEMENT 2 SEATER RIGHT WITH 2 RECLINERS	72/96	170	110	1,3	
MTEB19	MATISSE END ELEMENT 2 SEATER LEFT WITH 2 RECLINERS	72/96	170	110	1,3	
MTEA62	MATISSE END ELEMENT 1 SEATER RIGHT	72/96	95	110	1,3	60
MTEA63	MATISSE END ELEMENT 1 SEATER LEFT	72/96	95	110	1	
MTEA66	MATISSE END ELEMENT 1 SEATER WITH RECLINER RIGHT	72/96	95	110	1	
MTEA67	MATISSE END ELEMENT 1 SEATER WITH RECLINER LEFT	72/96	95	110	1	
MTEE76	MATISSE END ELEMENT 1 SEATER WITH MOVABLE ARMREST RIGHT	72/96	122	110	1	
MTEE77	MATISSE END ELEMENT 1 SEATER WITH MOVABLE ARMREST LEFT	72/96	122	110	1	
MTEE62	MATISSE END ELEM. 2 SEATER RIGHT WITH MOVABLE ARMREST	72 /96	190	110	1.5	
MTEE63	MATISSE END ELEM. 2 SEATER LEFT WITH MOVABLE ARMREST	72 /96	190	110	1.5	
MTEA64	MATISSE CENTRAL ELEMENT	72/96	70	110	0,5	28
MTEA65	MATISSE CENTRAL ELEMENT RECLINER	72/96	70	110	0,5	38
MTEB64	MATISSE CENTRAL ELEMENT 2 SEATER	72/96	140	110	1	76
MTEE78	MATISSE CHAISE LONGUE RIGHT	72/96	97	183	1	50
MTEE79	MATISSE CHAISE LONGUE LEFT	72/96	97	183	1	50
MTEE01	MATISSE CORNER	56	122	122	1	46
MTEE21	MATISSE SOUND CORNER	56	122	122	1	50
MTEF22	MATISSE BACK CUSHION	5	50	40	0,01	2
MTED01	MATISSE FOOTSTOOL	37	90	60	0,2	13
MTEA34	MATISSE STORAGE	72	48	110	0,4	15
MTEA35	MATISSE STORAGE SOUND	72	48	110	0,4	25
MTEB68	MATISSE SOFABED 200 CM	72/96	200	110	2,2	
MTEC61	MATISSE SOFBED 220 CM	72/96	220	110	2,4	
MTEC68	MATISSE SOFBED 230 CM	72/96	230	110	2,5	

Matisse L.

MATISSE BED VERSION

CODES	ELEMENTS	H	L	D	V	W
LMTA62	MATISSE L. END ELEMENT 1 SEATER RIGHT HEADREST	76	95	110	0.8	
LMTA63	MATISSE L. END ELEMENT 1 SEATER LEFT HEADREST	76	95	110	0.8	
LMTA64	MATISSE L. CENTRAL ELEMENT 1 SEATER HEADREST	76	70	110	0.4	
LMTA65	MATISSE L. CENTRAL ELEMENT 1 SEATER HEADREST RECLINER	76	70	110	0.4	
LMTA66	MATISSE L. END ELEMENT 1 SEATER RIGHT HEADREST RECLINER	76	95	110	0.8	
LMTA67	MATISSE L. END ELEMENT 1 SEATER LEFT HEADREST RECLINER	76	95	110	0.8	
LMTB16	MATISSE L. END ELEMENT 2 SEATER RIGHT 2HEADREST RECLINER	76	170	110	1,5	
LMTB17	MATISSE L. END ELEMENT 2 SEATER LEFT 2HEADREST RECLINER	76	170	110	1,5	
LMTB24	MATISSE L. ELEMENT WITH BED 190 CM RIGHT	76	190	110	1,7	
LMTB25	MATISSE L. ELEMENT WITH BED 190 CM LEFT	76	190	110	1,7	
LMTB62	MATISSE L. END ELEMENT 2 SEATER RIGHT 2HEADREST	76	170	110	1,5	
LMTB63	MATISSE L. END ELEMENT 2 SEATER LEFT 2HEADREST	76	170	110	1,5	
LMTB64	MATISSE L. CENTRAL ELEMENT 2 SEATER 2HEADREST	76	140	110	1.1	
LMTE01	MATISSE L. CORNER	60	122	122	0.9	
LMTE21	MATISSE L. CORNER SOUND	60	122	122	0.9	
LMTE73	MATISSE L. CHAISE LONGUE RIGHT HEADREST	76	97	183	1.34	
LMTE74	MATISSE L. CHAISE LONGUE LEFT HEADREST	76	97	183	1.34	

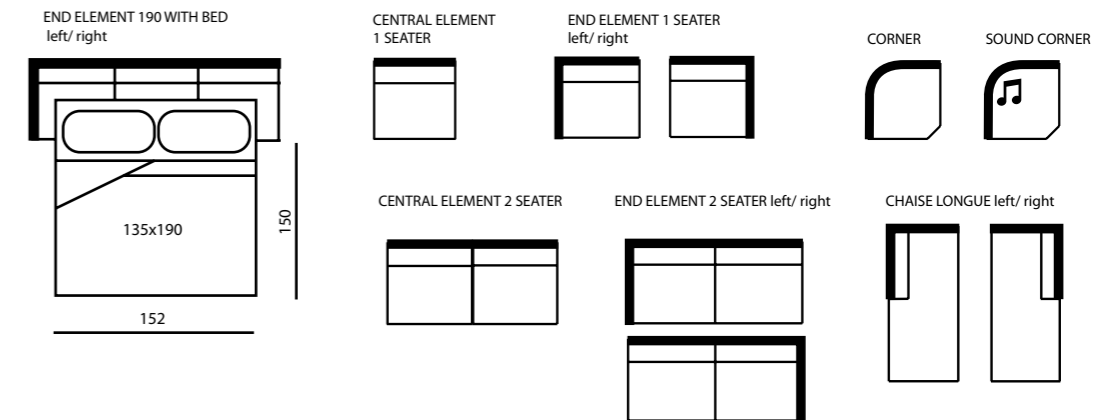

- * Adjustable headrests are a characteristic of each piece, with or without recliner. In order not to break the internal headrests mechanism v suggest to lift up the headrest adjust it in one of the 3 possible positions and to bring it back, push it forward till you feel the mechanism soft and bring it back in horizontal position.
- * When recliner mechanism is chosen for a central seat or for an internal element the touch up buttons are hidden between the seat cushion.
- * In case you order a fixed end element and a recliner or bed element to join with it is possible that the balance of the whole sofa is not stab due to the different weights of the elements.
- * In case of multiple recliners in a same composition plugs will be multiple. It is not possible to plug in all elements with the same plug.
- * Loose pillows are not included in the composition. In case you order a Corner Element please also choose the corresponding back seat loo pillows 50x70 cm.
- * Corner Sound or Sound Storage devices can be used to reproduce MP3, iPhones, iPods etc.
- * Different combination of coverings or different sizes are not previewed in our system. Special requests will be considered a "non standa product" and a 10% surcharge will be applied.



MODERN
COLLECTION

_Camaleon

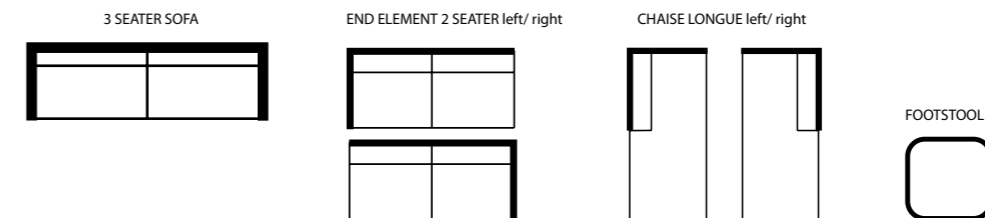

CODES	ELEMENTS	H	L	D	V	W
CMLB73	CAMALEON END ELEM. LEFT W/ 2 MECHANICAL BACKSEATS	90	180	115	1,8	65
CMLB72	CAMALEON END ELEM. RIGHT W/ 2 MECHANICAL BACKSEATS	90	180	115	1,8	65
CMLC32	CAMALEON 3 SEATER	90	180	115	1,9	70
CMLE73	CAMALEON CHAISE LONGUE LEFT WITH MECHANICAL BACKREST	90	110	230	2,3	75
CMLE72	CAMALEON CHAISE LONGUE RIGHT WITH MECHANICAL BACKREST	90	110	230	2,3	75
CMLA04	CAMALEON CENTRAL ELEMENT	90	80	115	0,8	30
CMLD01	CAMALEON FOOTSTOOL	42	70	70	0,2	15

- * Movable metal back and forth mechanism for back seats and armrests. We do not recommend sitting on opened armrests.
- * For moving the back seats back and forth slip your hands underneath the back cushions and pull up in vertical and then horizontal movement. Do not push or pull without lifting the backseat at the same time.
- * Different combination of coverings are not previewed in our system. Special requests will be considered a “non standard product” and a 10% surcharge will be applied.

MODERN COLLECTION

_Liz



CODES	ELEMENTS	H	L	D	V	W
LIZA01	LIZ CASUAL ARMCHAIR	77	86	87	0,5	28
LIZB01	LIZ 2 SEATER	82	185	96	1,5	88
LIZB80	LIZ 2 SEATER W/ 2 ELECTRICAL RECLINER	82	185	144	1,5	92
LIZC01	LIZ 3 SEATER	82	215	96	1,7	100
LIZC80	LIZ 3 SEATER W/ 2 ELECTRIC RECLINER	82	215	100	1,7	105
LIZF39	LIZ HEADRESTS FOR 2 SEATER	22	54	12		
LIZF40	LIZ HEADRESTS FOR 3 SEATER	22	70	12		

- * Headrests and decor cushions needs to be ordered separately. Lumbar supports are included in the price.
- * When chosen with recliners touch up buttons are always located on the armrests.
- * In case of multiple recliners in a same composition plugs will be multiple. It is not possible to plug in all elements with the same plug.
- * We strongly recommend ordering headrests when a recliner or two are chosen for the composition. Laying position might otherwise result uncomfortable.
- * For 2 and 3 seater big contrast thread stitching is a typical characteristic of the model and cannot be chosen or changed without an extra surcharge of 10%. For a specific thread color please indicate it at the moment of the order.
- * For armchair normal tone sur tone stitching is used and cannot be chosen or changed without an extra surcharge of 10%. For a specific thread color please indicate it at the moment of the order.
- * For Liz armchair recliner version is not available.
- * Different combination of coverings or different sizes are not previewed in our system. Special requests will be considered a "non standard product" and a 10% surcharge will be applied.



MODERN
COLLECTION

_Avatar

CODES	ELEMENTS	H	L	D	V	W
AVTB02	AVATAR END ELEMENT 2 SEATER RIGHT	80	165	102	1,4	70
AVTB03	AVATAR END ELEMENT 2 SEATER LEFT	80	165	102	1,4	70
AVTA04	AVATAR CENTRAL ELEMENT 1 SEATER	80	102	85	0,8	28
AVTD01	AVATAR FOOTSTOOL	40	85	80	0,4	39
AVTE01	AVATAR CORNER	80	120	120	1,2	25



END ELEMENT 2 SEATER left/ right

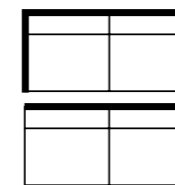

CENTRAL ELEMENT
1 SEATER



CORNER



FOOTSTOOL



* Different combination of coverings or different sizes are not previewed in our system. Special requests will be considered a "non standard product" and a 10% surcharge will be applied.

MODERN COLLECTION

_Alifax



2 SEATER SOFA

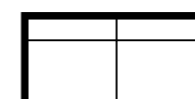

3 SEATER SOFA



CODES	ELEMENTS	H	L	D	V	W
ALFB01	ALIFAX 2 SEATER	80	185	103	1,5	67
ALFC01	ALIFAX 3 SEATER	80	228	103	1,9	68

* Different combination of coverings or different sizes are not previewed in our system. Special requests will be considered a "non standard product" and a 10% surcharge will be applied.

MODERN
COLLECTION

_Tom



END ELEMENT 2 SEATER
left/ right

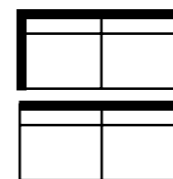

CHAISE LONGUE
left/ right

CODES	ELEMENTS	H	L	D	V	W
TOMB02	TOM END ELEMENT RIGHT	80	180	102	1,5	50
TOMB03	TOM END ELEMENT LEFT	80	180	102	1,5	50
TOME06	TOM CHAISE LONGUE RIGHT	80	182	102	1,5	49
TOME07	TOM CHAISE LONGUE LEFT	80	182	102	1,5	49

* Different combination of coverings or different sizes are not previewed in our system. Special requests will be considered a “non standard product” and a 10% surcharge will be applied.

CLASSICAL COLLECTION



CLASSICAL
COLLECTION

_Canaletto



2 SEATER SOFA



3 SEATER SOFA



CODES	ELEMENTS	H	L	D	V	W
CNAB01	CANALETTO 2 SEATER	84	198	100	1.7	48
CNAC01	CANALETTO 3 SEATER	84	228	100	1.9	53



- * The sofa is supplied with two standard litte round pillows in the same covering as the sofa, NOT to be purchased alone.
- * When ordered in leather and fabric the backseat part in chester can only be realized in leather.
- * Available in all finishing except briarwood, macassar, zebranwood and wengè.
- * An extra 10% on the price has to be added by any non standard modification of the external sight.
- * Seat cushions removable and changeble.

CLASSICAL
COLLECTION

_Fitzgerald



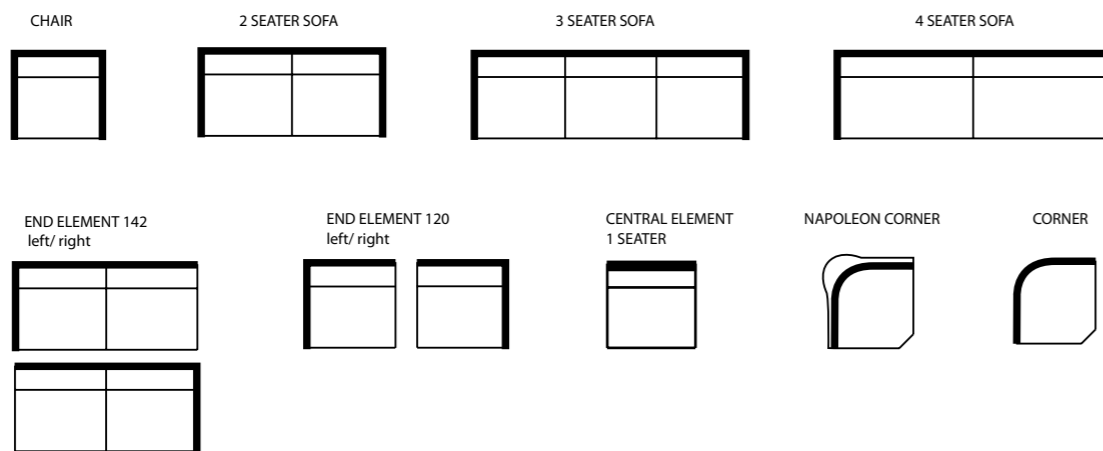

CODES	ELEMENTS	H	L	D	V	W
FITB01	FITZGERALD 2 SEATER	75	100	100	0,8	48
FITC01	FITZGERALD 3 SEATER	90	190	110	1,9	44
FITC40	FITZGERALD 4 SEATER	90	236	110	2,3	54
FITE15	FITZGERALD NAPOLEON CORNER	90	280	110	2,7	64
FITE01	FITZGERALD ROUND CORNER	95	110	133	1,3	44
FITA04	FITZGERALD CENTRAL ELEMENT	90	110	133	1,1	34
FITA02	FITZGERALD END ELEMENT RIGHT 120 CM	90	70	110	0,6	30
FITA03	FITZGERALD END ELEMENT LEFT 120 CM	90	120	110	1,3	34
FITB02	FITZGERALD END ELEMENT RIGHT 142 CM	90	120	110	1,2	34
FITB03	FITZGERALD END ELEMENT LEFT 142 CM	90	142	110	1,4	44
FSWB01	FITZGERALD SW 2 SEATER	90	190	110	1,9	44
FSWC01	FITZGERALD SW 3 SEATER	90	236	110	2,3	54
FSWC40	FITZGERALD SW 4 SEATER	90	280	110	2,7	64
FSWE15	FITZGERALD SW NAPOLEON CORNER	95	110	133	1,3	35
FSWE01	FITZGERALD SW ROUND CORNER	90	110	133	1,1	35
FWSA04	FITZGERALD SW CENTRAL ELEMENT	90	70	110	0,6	30
FSWA20	FITZGERALD SW ROLL CHAIR	76	100	100	0,8	48
FITA02	FITZGERALD SW END ELEMENT RIGHT 120 CM	90	120	110	1,3	34
FSWA03	FITZGERALD SW END ELEMENT LEFT 120 CM	90	120	110	1,3	34
FITB02	FITZGERALD SW END ELEMENT RIGHT 142 CM	90	142	110	1,4	44
FSWB03	FITZGERALD SW END ELEMENT LEFT 142 CM	90	142	110	1,4	44

- * There are 3 versions of this model with respective codification: FSW- with Swarovskies around the edges of the back cushions as well as around the base of the sofa; FIT- without any Swarovskies. On the sofa there are buttons covered with the same leather; FSS- Swarovskies only on the edges of the sofa.
- * There are also two versions of the cornersets: the round corner with a rectangular backcushion and the corner "Napoleon" which has a slightly rounded backcushion (like Napoleon's hat). Both have in total 6 backcushions with a slip into wooden mechanism and 2 loose cushions.
- * The 2 seater has by default 4 backcushions, the 3 seater has 5, and the 4 seater has 6.
- * The Swarovsky stones of the backcushions are mounted on stainless nickel-containing metal.
- * There are two loose pillows with sewed on Swarovsky included in the price. Those cushions cannot be reordered as it serves except as a replacement.
- * The sofa's legs are made in metal and plastic and are screwed in beneath the sofa and not visible.

CLASSICAL
COLLECTION

_Romeo



2 SEATER SOFA



3 SEATER SOFA

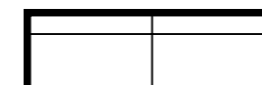

CODES	ELEMENTS	H	L	D	V	W
ROEB01	ROMEO 2 SEATER	79	190	96	1,5	44
ROEC01	ROMEO 3 SEATER	79	230	96	1,8	54

- * When ordered in leather and fabric the backseat part in chester can only be realized in leather and will always be on the right side. Only seat cushions and the plain left side of the backseat can be realized in fabric.
- * An extra 10% on the price has to be added by any non standard modification of the external sight.
- * Available in all finishing except briarwood, macassar, zebrano and wengè.
- * Light padding piece of furniture (please see sales conditions).
- * Seat cushions removable and changeable.

CLASSICAL COLLECTION

_Planet

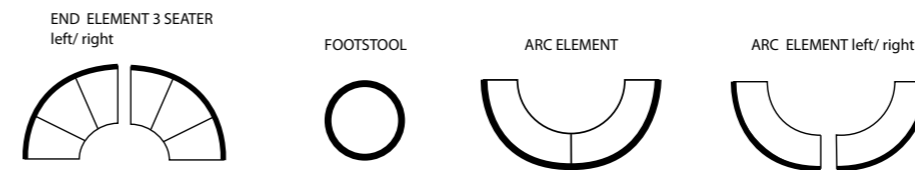

CODES	ELEMENTS	H	L	D	V	W
PLNC02	PLANET END ELEMENT 3 SEATER RIGHT	100	141	190	2,68	45,5
PLNC03	PLANET END ELEMENT 3 SEATER LEFT	100	141	190	2,68	45,5
PLND01	PLANET ARC ELEMENT	46	240	102	1,13	30
PLNE10	PLANET ARC ELEMENT LEFT	46	120	102	0,6	20
PLNE11	PLANET ARC ELEMENT RIGHT	46	120	102	0,6	20
PLND07	PLANET FOOTSTOOL MAX	46	136	113	0,7	42

- * Available also a modern version with leather covered base and aluminium base profile. Referred as model MARS.
- * An extra 10% on the price has to be added by any non standard modification of the external sight.
- * Available in all finishing except briarwood, macassar, zebrano and wengè.
- * Light padding piece of furniture (please see sales conditions).
- * Back cushions removable and changeable.

CLASSICAL COLLECTION

_Corniche

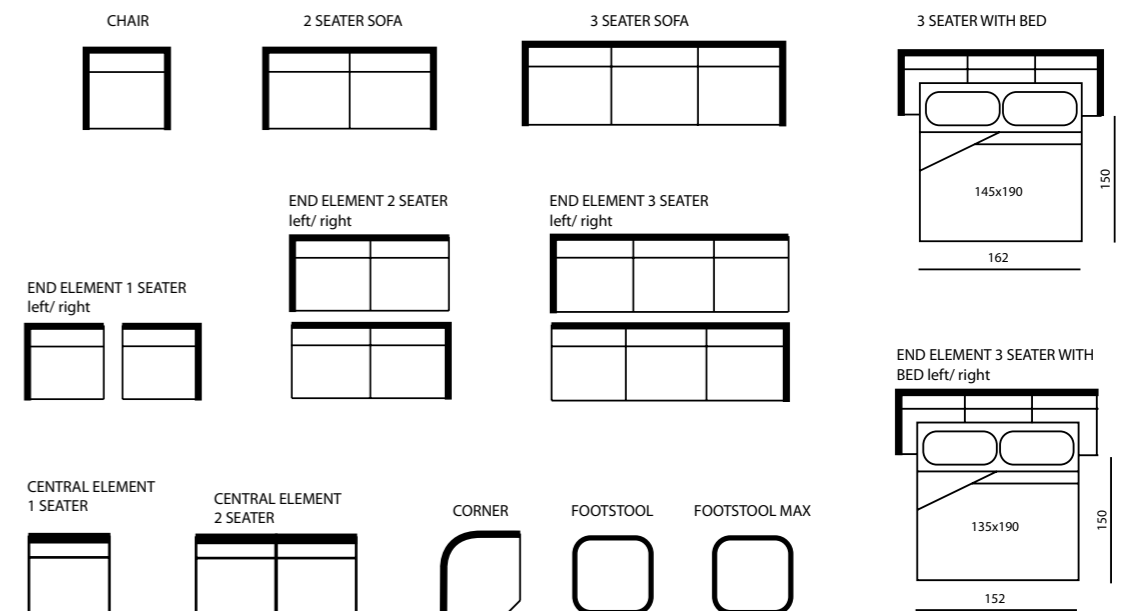



CODES	ELEMENTS	H	L	D	V	W
CNHA01	CORNICHE ARMCHAIR	90	117	105	1,1	33
CNHB01	CORNICHE 2 SEATER	90	172	105	1,6	48
CNHC01	CORNICHE 3 SEATER	90	232	105	2,2	60
CNHA02	CORNICHE END ELEMENT 1 SEATER RIGHT	90	86	105	0,9	19
CNHA03	CORNICHE END ELEMENT 1 SEATER LEFT	90	86	105	0,9	19
CNHA04	CORNICHE CENTRAL ELEMENT 1 SEATER	90	60	105	0,6	16
CNHB03	CORNICHE END ELEMENT 2 SEATER LEFT	90	146	105	1,4	30
CNHB02	CORNICHE END ELEMENT 2 SEATER RIGHT	90	146	105	1,4	30
CNHB04	CORNICHE CENTRAL ELEMENT 2 SEATER	90	120	105	1,1	28
CNHC08	CORNICHE 3 SEATER ORTHOPEDIC BED	95	232	105	2,2	78
CNHC02	CORNICHE END ELEMENT 3 SEATER RIGHT	90	206	105	2	50
CNHC03	CORNICHE END ELEMENT 3 SEATER LEFT	90	206	105	2	50
CNHC24	CORNICHE END ELEMENT 3 SEATER RIGHT WITH ORTHOPEDIC BED	95	206	105	2	65
CNHC25	CORNICHE END ELEMENT 3 SEATER LEFT WITH ORTHOPEDIC BED	95	206	105	2	65
CNHD07	CORNICHE FOOTSTOOL MAX	45	80	60	0,5	13
CNHE01	CORNICHE CORNER	90	118	105	1,1	33
CNHD01	CORNICHE FOOTSTOOL	40	60	60	0,14	10

- * Standard with briarwood.
- * Available without briar in Nieri colors, sample reference or Ral reference with 5% additional charge.
- * An extra 10% on the price has to be added by any non standard modification of the external sight.
- * For information about bed version please see model Bentley notes.
- * Back, seat and armrest cushions are removable and changeable.

CLASSICAL
COLLECTION



_Bentley



CODES	ELEMENTS	H	L	D	V	W
BTYA01	BENTLEY ARMCHAIR	90	117	105	1,1	33
BTYB01	BENTLEY 2 SEATER	90	172	105	1,63	48
BTYC01	BENTLEY 3 SEATER	90	232	105	2,2	60
BTYC08	BENTLEY 3 SEATER WITH ORTHOPEDIC BED	90	232	105	2,2	78
BTYA02	BENTLEY END ELEMENT 1 SEATER RIGHT	90	86	105	0,9	19
BTYA03	BENTLEY END ELEMENT 1 SEATER LEFT	90	86	105	0,9	19
BTYA04	BENTLEY CENTRAL ELEMENT 1 SEATER	90	60	105	0,6	16
BTYB04	BENTLEY CENTRAL ELEMENT 2 SEATER	90	120	105	1,1	28
BTYB02	BENTLEY END ELEMENT 2 SEATER RIGHT	90	146	105	1,4	30
BTYB03	BENTLEY END ELEMENT 2 SEATER LEFT	90	146	105	1,4	30
BTYC02	BENTLEY END ELEMENT 3 SEATER RIGHT	90	206	105	2	50
BTYC03	BENTLEY END ELEMENT 3 SEATER LEFT	90	206	105	2	50
BTYC17	BENTLEY END ELEMENT 3 SEATER RELAX LEFT	90	206	181	3,7	88
BTYC16	BENTLEY END ELEMENT 3 SEATER RELAX RIGHT	90	206	181	3,7	88
BTYC24	BENTLEY END ELEMENT 3 SEATER RIGHT WITH ORTHOPEDIC BED	90	206	105	2	65
BTYC25	BENTLEY END ELEMENT 3 SEATER LEFT WITH ORTHOPEDIC BED	90	206	105	2	65
BTYE01	BENTLEY CORNER	90	118	105	1,1	33
BTYD01	BENTLEY FOOTSTOOL	40	60	60	0,14	10
BTYD07	BENTLEY FOOTSTOOL MAX	42	80	60	0,5	13

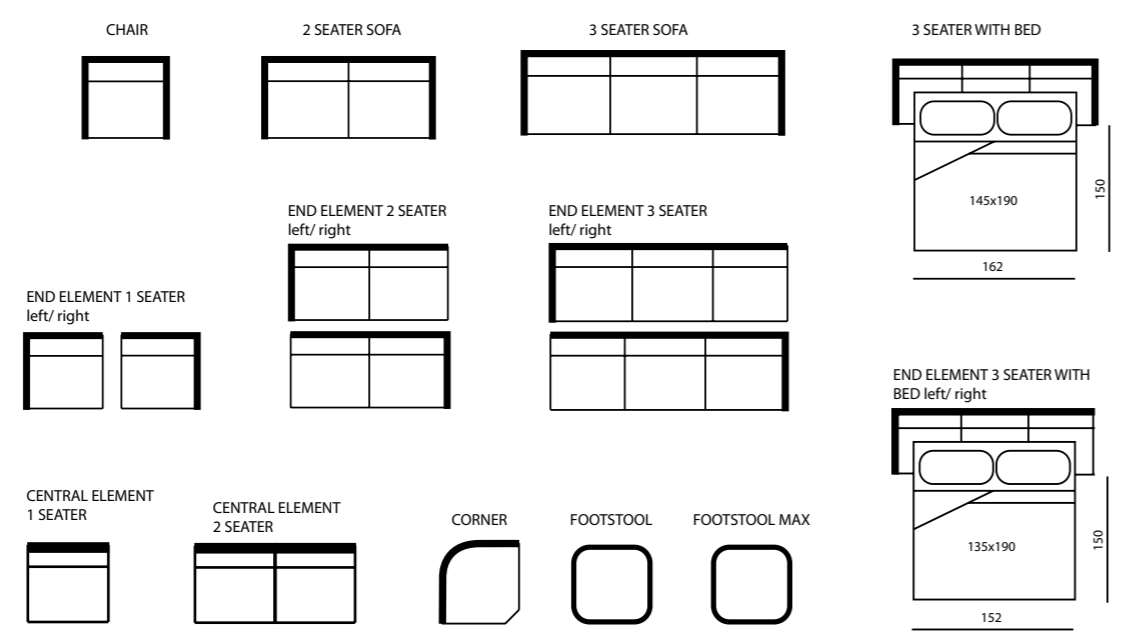

- * On request Help cushion for lumbar support.
- * The height of the legs bedversion is 6 cm higher so that there will be a height differences with the normal armchairs even if ordered together.
- * The version with bed shows slight differences in the external aspect and the seat comfort. There is a visible front covering under the bottom frame in order to cover the mattress from the external sight. Please ask for any other technical information.
- * An extra 10% on the price has to be added by any non standard modification of the external sight.
- * Seat option Extra Comfort and Traditional Springs not available.
- * Light padding piece of furniture (please see sales conditions).
- * Back, seat and armrest cushions removable and changeable.

CLASSICAL
COLLECTION

_Geisha



CODES	ELEMENTS	H	L	D	V	W
GEIA01	GEISHA ARMCHAIR	83	96	114	1,1	33
GEIB01	GEISHA 2 SEATER	83	190	114	1,8	54
GEIC01	GEISHA 3 SEATER	83	220	114	2	65

- * Built in bed not available.
- * Feather inlay in seat cushions.
- * Available in all finishing except briarwood, macassar, zebranwood and wengè.

CLASSICAL
COLLECTION

_Zen

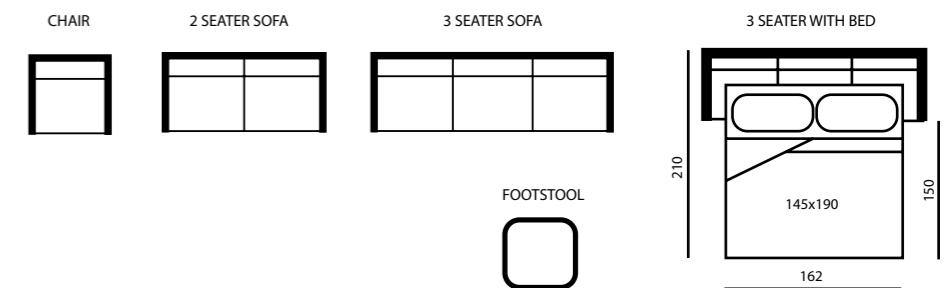

CODES	ELEMENTS	H	L	D	V	W
ZENA01	ZEN ARMCHAIR	78	120	112	1,05	36
ZENB01	ZEN 2 SEATER	78	200	112	1,7	51
ZENC01	ZEN 3 SEATER	78	230	112	2	60
ZENC08	ZEN 3 SEATER WITH ORTHOPEDIC BED	78	230	112	2	72
ZEND01	ZEN FOOTSTOOL	41	64	64	0,15	10

- * An extra 10% on the price has to be added by any non standard modification of the external sight.
- * Standard Macassar.
- * Available in all finishing except briarwood, zebranwood and wengè.
- * Seat density available with option Extra Comfort and Traditional Springs.
- * Light padding piece of furniture (please see sales conditions).
- * Back cushion and armrest cushion removable and changeable.

CLASSICAL
COLLECTION

_Monaco

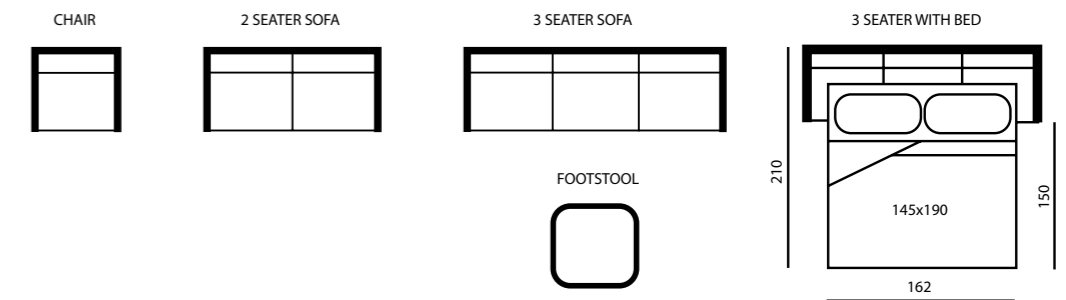

CODES	ELEMENTS	H	L	D	V	W
MCOA01	MONACO ARMCHAIR	78	120	112	1,05	36
MCOB01	MONACO 2 SEATER	78	200	112	1,7	51
MCOC01	MONACO 3 SEATER	78	230	112	2	60
MCOC08	MONACO 3 SEATER WITH ORTHOPEDIC BED	78	230	112	2	72
MCOD01	MONACO FOOTSTOOL	41	64	64	0,15	10

- * An extra 10% on the price has to be added by any non standard modification of the external sight.
- * Available in all finishing except briarwood, macassar, zebrano and wengè.
- * Each 2 and 3 seater are provided of 2 lombar cushions, 1 for the armchair.
- * Light padding piece of furniture (please see sales conditions)
- * Back cushion and armrest cushion removable and changeable.



_Orchidea

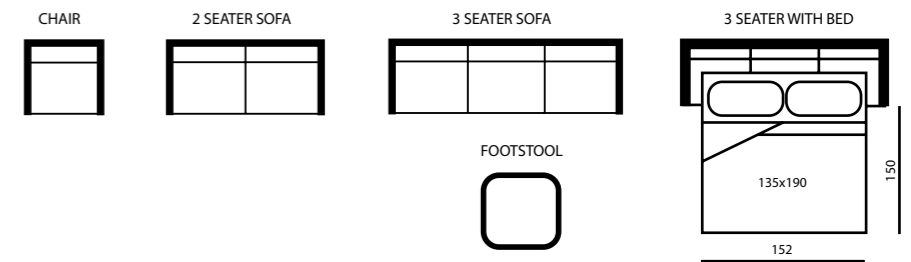

CODES	ELEMENTS	H	L	D	V	W
ORNA01	ORCHIDEA ARMCHAIR	90	110	100	1	23
ORNB01	ORCHIDEA 2 SEATER	90	165	100	1,5	36
ORNC01	ORCHIDEA 3 SEATER	90	220	100	2	57
ORND01	ORCHIDEA FOOTSTOOL	45	60	60	0,2	10
ORNC08	ORCHIDEA 3 SEATER WITH ORTHOPEDIC BED	90	220	100	2	77

* An extra 10% on the price has to be added by any non standard modification of the external sight.

* Available in all finishing except briarwood, macassar, zebrano and wengè.

* Light padding piece of furniture (please see sales conditions).

* Seat cushion removable and changeable.

CLASSICAL COLLECTION

_Morgan

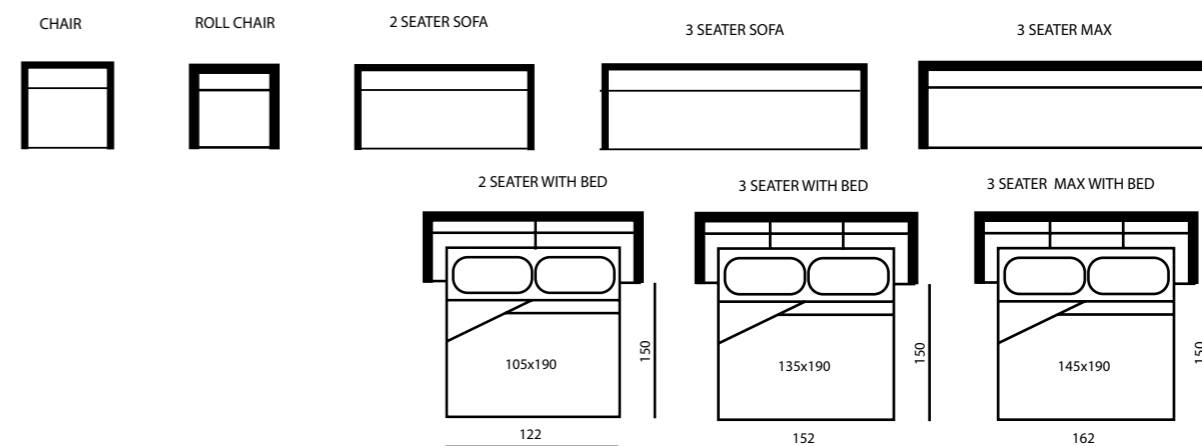

CODES	ELEMENTS	H	L	D	V	W
MORA01	MORGAN CHAIR	124	94	94	1	34
MORA20	MORGAN ROLL CHAIR	126	94	94	1	49
MORB01	MORGAN 2 SEATER	85	205	101	1,8	52
MORB08	MORGAN 2 SEATER WITH ORTHOPEDIC BED	85	205	101	1,8	81
MORC01	MORGAN 3 SEATER	85	239	101	2	58
MORC07	MORGAN 3 SEATER MAX	85	256	101	2,2	60
MORC08	MORGAN 3 SEATER WITH ORTHOPEDIC BED	85	239	101	2	88
MORC37	MORGAN 3 SEATER MAX WITH ORTHOPEDIC BED	85	256	101	2,2	90

- * When ordered in leather and fabric the backseat part in chester can only be realized in leather.
- * An extra 10% on the price has to be added by any non standard modification of the external sight.
- * Available in all finishing except briarwood, macassar, zebranwood and wengè.
- * Light padding piece of furniture (please see sales conditions).
- * Seat cushion removable and changeble.

CLASSICAL COLLECTION

_Chester

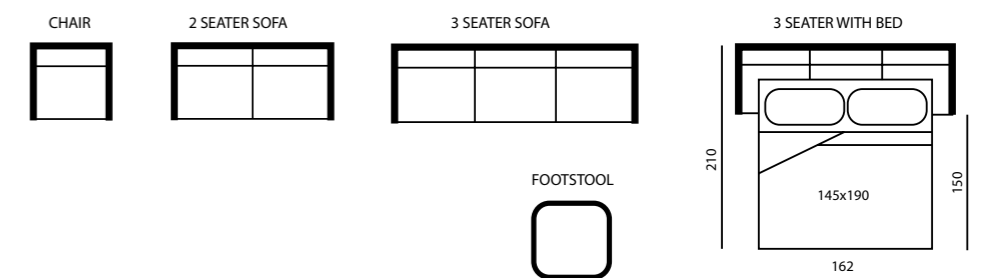

CODES	ELEMENTS	H	L	D	V	W
CHEA01	CHESTER CHAIR	78	115	90	1,8	34
CHEB01	CHESTER 2 SEATER	78	165	90	1,2	44
CHEC01	CHESTER 3 SEATER	78	220	90	1,6	55
CHEC08	CHESTER 3 SEATER WITH ORTHOPEDIC BED	78	220	95	1,2	70
CHED01	CHESTER FOOTSTOOL	46	58	68	0,2	10

- * Chesterfield working only available with leather coverings.
- * Available in all finishing except briarwood, macassar, zebrano and wengè.
- * An extra 10% on the price has to be added by any non standard modification of the external sight.
- * Seat cushion removable and changeable.

CLASSICAL
COLLECTION

_Manchester



2 SEATER SOFA

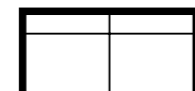

3 SEATER SOFA

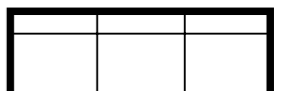

CODES	ELEMENTS	H	L	D	V	W
MANB01	MANCHESTER 2 SEATER	80	192	95	1,5	53
MANC01	MANCHESTER 3 SEATER	80	222	95	1,7	59

* An extra 10% on the price has to be added by any non standard modification of the external sight.
* Available in all finishing except briarwood, macassar, zebrano and wengè.

CLASSICAL
COLLECTION

_New York

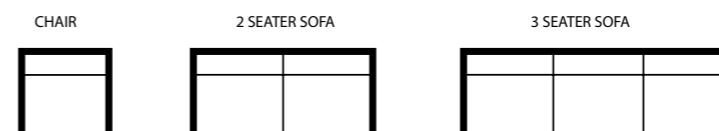

CODES	ELEMENTS	H	L	D	V	W
NWYA01	NEW YORK ARMCHAIR	82	95	98	0,72	38,5
NWYB07	NEW YORK 2 SEATER MAX	82	180	98	1,4	56
NWYC01	NEW YORK 3 SEATER	82	210	98	1,7	69,5

- * Attention! The requested polishing has to be specified clearly in your purchase order e.g. "See sample enclosed".
- * A 5% surcharge is to be paid for a new polishing without the standard briarwood and 4 weeks added to the standard delivery time.
- * On request Help Cushions for lumbar support.
- * Available in all coating finishings.
- * Light padding piece of furniture (please see sales conditions).
- * Seat and back cushions removable and changeable.

CLASSICAL COLLECTION

_Pompei

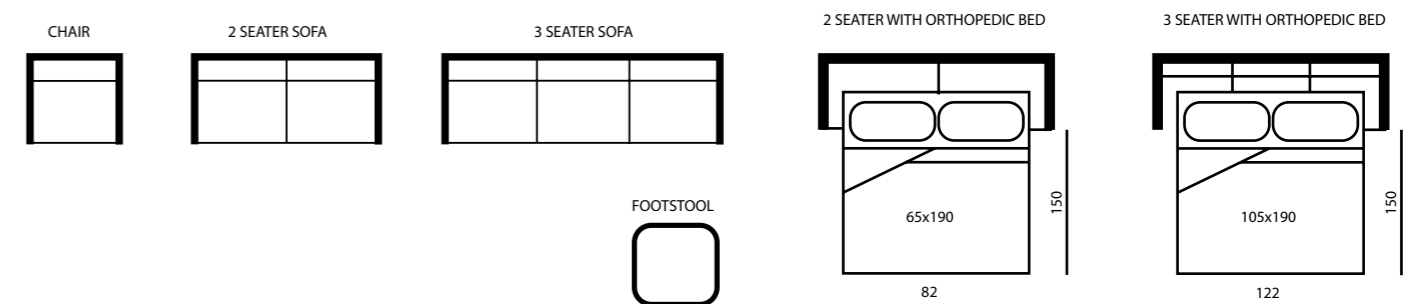

CODES	ELEMENTS	H	L	D	V	W
PMPA01	POMPEI ARMCHAIR	95	103	95	0,93	23,5
PMPB01	POMPEI 2 SEATER	95	150	95	1,35	34,5
PMPC01	POMPEI 3 SEATER	95	200	95	1,81	45
PMPB08	POMPEI 2 SEATER WITH ORTHOPEDIC BED	95	150	95	1,35	47
PMPC08	POMPEI 3 SEATER WITH ORTHOPEDIC BED	95	200	95	1,81	57
PMPD01	POMPEI FOOTSTOOL	48	56	56	0,15	11,5

- * An extra 10% on the price has to be added by any non standard modification of the external sight.
- * Available in all finishing except briarwood, macassar, zebrano and wengè.
- * Light padding piece of furniture (please see sales conditions).
- * Seat cushion removable and changeable.

CLASSICAL COLLECTION

_Incas

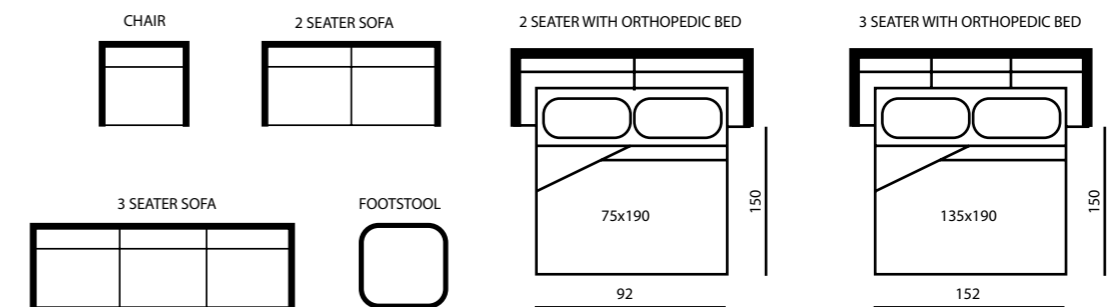

CODES	ELEMENTS	H	L	D	V	W
INCA01	INCAS CHAIR	94	92	96	0,83	22
INCB01	INCAS 2 SEATER	94	145	96	1,3	33
INCB08	INCAS 2 SEATER WITH ORTHOPEDIC BED	96	145	96/236	1,3	54
INCC01	INCAS 3 SEATER	94	198	96	1,8	44
INCC08	INCAS 3 SEATER WITH ORTHOPEDIC BED	94	198	96/236	1,8	81
INCD01	INCAS FOOTSTOOL	40	60	60	0,1	12

* An extra 10% on the price has to be added by any non standard modification of the external sight.
 * Available in all finishing except briarwood, macassar, zebrano and wengè.
 * Seat cushion removable and changeable.

CLASSICAL COLLECTION

_Palatino

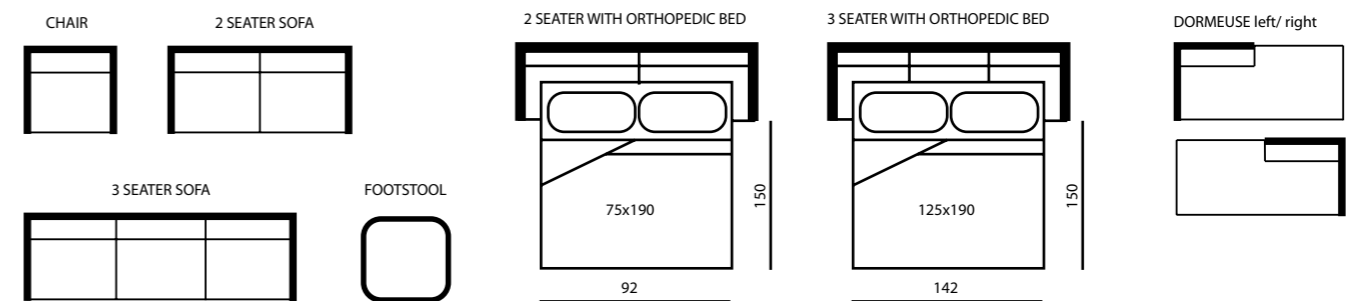

CODES	ELEMENTS	H	L	D	V	W
PLTA01	PALATINO ARMCHAIR	96	100	97	1	26
PLTB01	PALATINO 2 SEATER	96	153	97	1,42	35
PLTC01	PALATINO 3 SEATER	96	193	97	1,8	43
PLTB08	PALATINO 2 SEATER WITH ORTHOPEDIC BED	96	153	97	1,4	47
PLTE05	PALATINO CHAISE LONGUE LEFT	78	188	88	1,3	39
PLTE04	PALATINO CHAISE LONGUE RIGHT	78	188	88	1,3	39
PLTD01	PALATINO FOOTSTOOL	45	58	58	0,45	13,5

- * An extra 10% on the price has to be added by any non standard modification of the external sight.
- * Available in all finishing except briarwood, macassar, zebrano and wengè.
- * Seat density available with option Extra Comfort. Not available with Traditional Springs.
- * Light padding piece of furniture (please see sales conditions).
- * Seat cushion removable and changeable.

CLASSICAL
COLLECTION

_Farfalla



DORMEUSE left/ right

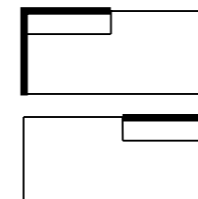

CODES	ELEMENTS	H	L	D	V	W
FRFE06	FARFALLA CHAISE LONGUE RIGHT	93	218	105	2,05	41
FRFE07	FARFALLA CHAISE LONGUE LEFT	93	218	105	2,05	41

- * Available in all finishing except briarwood, macassar, zebranwood and wengè.
- * An extra 10% on the price has to be added by any non standard modification of the external sight.
- * Light padding piece of furniture (please see sales condition).
- * Seat cushion removable and changeble.

CLASSICAL
COLLECTION

_Victoria

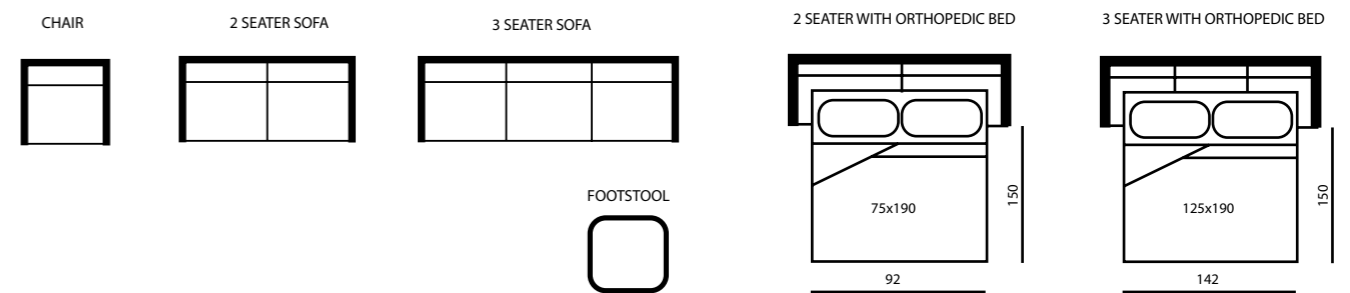

CODES	ELEMENTS	H	L	D	V	W
VCTA01	VICTORIA ARMCHAIR	92	95	98	0,86	22
VCTB01	VICTORIA 2 SEATER	92	145	98	1,31	32
VCTC01	VICTORIA 3 SEATER	92	195	98	1,76	42
VCTB08	VICTORIA 2 SEATER WITH ORTHOPEDIC BED	92	145	98	1,31	45
VCTC08	VICTORIA 3 SEATER WITH ORTHOPEDIC BED	92	195	98	1,76	55
VCTD01	VICTORIA FOOTSTOOL	44	54	54	0,2	12

- * An extra 10% on the price has to be added by any non standard modification of the external sight.
- * Available in all finishing except briarwood, macassar, zebrano and wengè.
- * Light padding piece of furniture (please see sales conditions).
- * Seat cushion removable and changeable.

CLASSICAL COLLECTION

_Elena

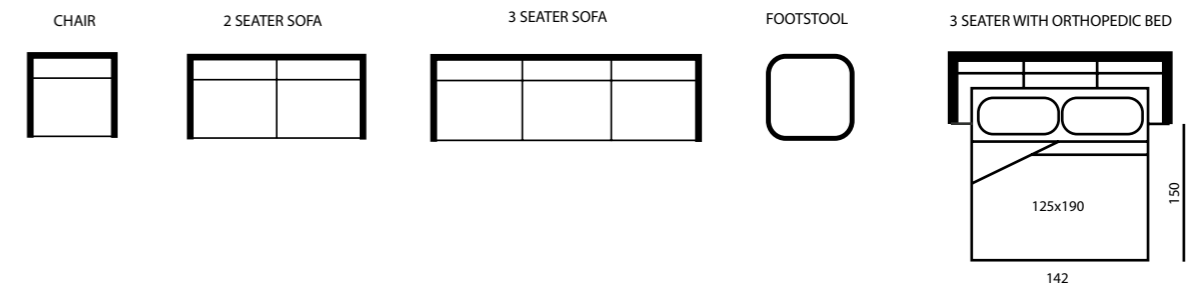

CODES	ELEMENTS	H	L	D	V	W
ELEA01	ELENA ARMCHAIR	102	96	85	0,9	19
ELEB01	ELENA 2 SEATER	102	135	96	1,32	50
ELEC01	ELENA 3 SEATER	102	185	96	1,81	48
ELEC08	ELENA 3 SEATER WITH ORTHOPEDIC BED	102	185	96	1,81	60
ELED01	ELENA FOOTSTOOL	40	60	60	0,2	10

- * Available in all finishing except briarwood, macassar, zebrano and wengè.
- * An extra 10% on the price has to be added by any non standard modification of the external sight.
- * Light padding piece of furniture (please see sales conditions)
- * Seat cushion removable and changeable.

CHAIRS



_Mida



CODES	ELEMENTS	H	L	D	V	W
MIDA01	MIDA ARMCHAIR	121	77	95	0,88	26
MIDD01	MIDA FOOTSTOOL	45	70	65	0,2	12,5

* Different combination of coverings or different sizes are not previewed in our system. Special requests will be considered a "non standard product" and a 10% surcharge will be applied.

CHAIRS

_Easy



CHAIR

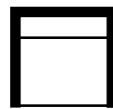

CODES	ELEMENTS	H	L	D	V	W
ESYA01	EASY ARMCHAIR	90	104	90	0,8	24
ESYA20	EASY ROLL CHAIR	90	104	90	0,8	27

* Different combination of coverings or different sizes are not previewed in our system. Special requests will be considered a “non standard product” and a 10% surcharge will be applied.

_Trocadero



CHAIR



CODES	ELEMENTS	H	L	D	V	W
TRCA01	TROCADERO ARMCHAIR	82	85	70	0,4	17,6

* Different combination of coverings or different sizes are not previewed in our system. Special requests will be considered a “non standard product” and a 10% surcharge will be applied.

CHAIRS

_Polo



CHAIR



CODES	ELEMENTS	H	L	D	V	W
POLA01	POLO ARMCHAIR	90	95	109	0.8	30

* Different combination of coverings or different sizes are not previewed in our system. Special requests will be considered a "non standard product" and a 10% surcharge will be applied.

_Pretorio



CHAIR



CODES	ELEMENTS	H	L	D	V	W
PRTA01	PRETORIO ARMCHAIR	86	82	78	0,55	17

* Different combination of coverings or different sizes are not previewed in our system. Special requests will be considered a "non standard product" and a 10% surcharge will be applied.

CHAIRS

_Cigar chair



CHAIR



FOOTSTOOL



CODES	ELEMENTS	H	L	D	V	W
CGKA01	CIGAR-CHAIR SILVER ARMCHAIR	101	98	98	0,97	33
CGKD01	CIGAR-CHAIR SILVER FOOTSTOOL	46	60	58	0,16	11
CGRA01	CIGAR-CHAIR ARMCHAIR	101	98	98	0,97	33
CGRD01	CIGAR-CHAIR FOOTSTOOL	46	60	58	0,16	11
MSWA01	MY CHAIR SW ARMCHAIR	101	98	98	0,97	33
MYCA01	MY CHAIR ARMCHAIR	101	98	98	0,97	33
MYCD01	MY CHAIR FOOTSTOOL	46	60	58	0,16	11

- * Different combination of coverings or different sizes are not previewed in our system. Special requests will be considered a "non standard product" and a 10% surcharge will be applied.
- * Personalized metal plate and ashtray with no additional charge.
- * Cigar chair has brass feet and brass plate.
- * **My chair** is an alternative version of Cigar Chair and it has default wooden feet and silver finished plaque.
- * Backseat part of My chair can be chosen with Swarovsky stones or leather/fabric covered bottoms.
- * Seat cushion is removable and changeable.

SOFABEDS

rapido



_Calypso

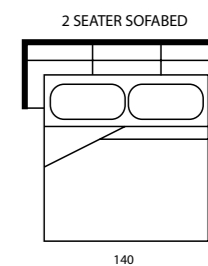

CODES	ELEMENTS	H	L	D	V	W
CLPB09	CALYPSO SOFABED	86	188	97/207	0,7	120

* Different combination of coverings or different sizes are not previewed in our system. Special requests will be considered a "non standard product" and a 10% surcharge will be applied.

SOFABEDS
rapido

_Swing

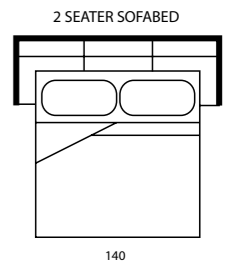

CODES	ELEMENTS	H	L	D	V	W
SWNB09	SWING SOFABED	84	205	97/207	1,8	107

* Different combination of coverings or different sizes are not previewed in our system. Special requests will be considered a "non standard product" and a 10% surcharge will be applied.

SOFABEDS
rapido

_Twist



2 SEATER SOFABED

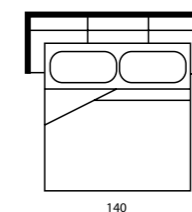

140

END ELEMENT 2 SEATER WITH BED
left/ right

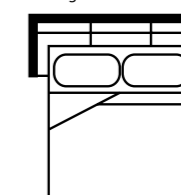

CHAISE LONGUE
left/ right

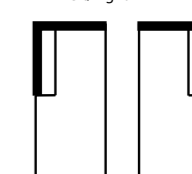

CODES	ELEMENTS	H	L	D	V	W
TWIE06	TWIST CHAISE LONGUE RIGHT	86	83	163	0,5	
TWIE07	TWIST CHAISE LONGUE LEFT	86	83	163	0,5	
TWIE57	TWIST CHAISE LONGUE LEFT WITH PILLOWCASE	86	83	163	0,5	
TWIB52	TWIST END ELEMENT 2 SEATER WITH BED RIGHT	86	174	97/207	1,4	100
TWIB53	TWIST END ELEMENT 2 SEATER WITH BED LEFT	86	174	97/207	1,4	100
TWIE56	TWIST CHAISE LONGUE RIGHT WITH PILLOWCASE	86	83	163	0,5	
TWIB09	TWIST SOFABED	86	188	97/207	1,7	118

* Different combination of coverings or different sizes are not previewed in our system. Special requests will be considered a "non standard product" and a 10% surcharge will be applied.

FOOTSTOOLS



FOOTSTOOLS

_Ginger k



_Roger



_Louis



_M2



_Apollon



_Aston



CODES	ELEMENTS	H	L	D	V	W
GIRD01	GINGER FOOTSTOOL	50	40	40	0,1	7
GIKD01	GINGER FOOTSTOOL K	50	40	40	0,1	12
RERD01	ROGER FOOTSTOOL	47,5	33	33	0,5	3
APOD10	APOLLON FOOTSTOOL-CASE 140	48	140	45	0,3	35
LOUD01	LOUIS FOOTSTOOL	37	90	60	0,2	13
MTED01	MATISSE FOOTSTOOL	37	90	60	0,2	13
MRKD07	M2 FOOTSTOOL	40	70	70	0,2	12,5
ASND01	ASTON FOOTSTOOL	108	108	45	0,4	27,5

* Different combination of coverings or different sizes are not previewed in our system. Special requests will be considered a "non standard product" and a 10% surcharge will be applied.

FOOTSTOOLS

_Bentley



_Corniche



_Incas



_Monaco/Zen



_Palatino



_Pompei



_Victoria



CODES	ELEMENTS	H	L	D	V	W
BTYD01	BENTLEY FOOTSTOOL	40	60	60	0,14	10
CNHD01	CORNICHE FOOTSTOOL	40	60	60	0,14	10
INCD01	INCAS FOOTSTOOL	40	60	60	0,1	12
MCOD01	MONACO FOOTSTOOL	41	64	64	0,15	10
ZEND01	ZEN FOOTSTOOL	41	64	64	0,15	10
PLTD01	PALATINO FOOTSTOOL	45	58	58	0,45	13,5
PMPD01	POMPEI FOOTSTOOL	48	56	56	0,15	11,5
VCTD01	VICTORIA FOOTSTOOL	44	54	54	0,2	12

* Different combination of coverings or different sizes are not previewed in our system. Special requests will be considered a "non standard product" and a 10% surcharge will be applied.

TABLES



TABLES

_Espace



_Ginger top



_Tender side



_Tender centrale



CODES	ELEMENTS	H	L	D	V	W
EPC056	ESPACE OVAL TABLE WITH TOP GLASS	37	165	98	0,6	58
GITD01	GINGER FOOTSTOOL TOP	50	40	40	0,1	12,5
TENT23	TENDER SIDE TABLE	43	50	50	0,1	20
TENT01	TENDER TABLE	32	90	90	0,3	27

* Different combination of coverings or different sizes are not previewed in our system. Special requests will be considered a "non standard product" and a 10% surcharge will be applied.

* Ginger footstool top, also available with wooden base.

DECORS



DECORS



CODES	ELEMENTS	H	L	D	V	W
FITF80	FITZGERALD PILLOW 45X45	25	45	45	0,05	2
FITF81	FITZGERALD PILLOW 50X50	25	50	50	1,5	2
FITF83	FITZGERALD PILLOW 50X70	25	50	70	0,05	2
FITF82	FITZGERALD PILLOW 55X55	25	55	55	0,05	2
FITF84	FITZGERALD PILLOW 65X65	25	65	65	0,06	2
FITF85	FITZGERALD PILLOW 75X50	25	75	55	0,07	2
FITF86	FITZGERALD PILLOW 80X50	25	80	50	0,08	2,2
FITF87	FITZGERALD PILLOW 80X65	25	80	65	0,09	2,6
FSWF80	FITZGERALD SW PILLOW 45X45	25	45	45	0,05	2
FSWF81	FITZGERALD SW PILLOW 50X50	25	50	50	1,5	2
FSWF83	FITZGERALD SW PILLOW 50X70	25	50	70	0,05	2
FSWF82	FITZGERALD SW PILLOW 55X55	25	55	55	0,05	2
FSWF84	FITZGERALD SW PILLOW 65X65	25	65	65	0,06	2
FSWF85	FITZGERALD SW PILLOW 75X50	25	75	55	0,07	2
FSWF86	FITZGERALD SW PILLOW 80X50	25	80	50	0,08	2,2
FSWF87	FITZGERALD SW PILLOW 80X65	25	80	65	0,09	2,6

DECORS



CODES	ELEMENTS	H	L	D	V	W
EPCF01	ESPACE BACK CUSHION	50	60	50	0,01	2
KESF01	KESPACE BACK CUSHION	50	60	50	0,01	2
METF24	METROPOLITAN BACK CUSHIONS		62	52	0,01	2
METF03	DECOR CUSHION		40	40	0,01	2
MRHF24	MARATHON BACK CUSHION JOLLY/CENTRAL		60	50	0,01	2
MRHF08	MARATHON SMALL BACK CUSHION		40	40	0,01	2
MTEF22	MATISSE BACK CUSHION	5	50	40	0,01	2
CUSF02	CUSHION DECOR 62	15	62	62	0,05	2,5
CUSF17	CUSHION DECOR 50X50	15	50	50	0,06	4
CUHEL	HELP CUSHION	40	40	5	0,08	0,8
CUSF03	CUSHION DECOR 40	25	40	40	0,04	1,5
CUSF20	CUSHION DECOR 45	25	45	45	0,5	4

ENGLISH

ITALIANO

DEUTSCHE

FRANCAIS

ESPAÑOL

LEGENDA

ARMCHAIR	POLTRONA	SESSEL	FAUTEUIL	BUTACA
2 SEATER	2 POSTI	2 SITZER	2 PLACES	2 PLAZAS
2,5 SEATER	2,5 POSTI	2,5 SITZER	2,5 PLACES	2,5 PLAZAS
2 SEATER RELAX RIGHT/LEFT	2 POSTI RELAX DX/SX	2 SITZER MIT OTTOMANE RECHTS/LINKS	2 PLACES RELAX DROITE/GAUCHE	2 PLAZAS RELAX DERECHO/IZQUIERDO
3 SEATER	3POSTI	3 SITZER	3 PLACES	3 PLAZAS
3 SEATER WITH MECHANISM	3 POSTI MECC	3 SITZER MIT FUNKTION	3 PLACES MECC	3 PLAZAS MECANISMO
3 SEATER WITH ORTHOPEDIC BED	3 POSTI LETTO ORTOPEDICO	3 SITZER MIT LATTENROSENBETT	3 PLACES LETTO ORTOPEDICO	3 PLAZAS CON CAMA ORTOPEDICO
3 SEATER MAX	3 POSTI MAX	3 SITZER MAX	3 PLACES MAX	3 PLAZAS MAX
3 SEATER MAX WITH CHAISE LONGUE RIGHT/LEFT	3 POSTI MAX RELAX DX/SX	3 SITZER MAX OTTOMANE RECHTS/LINKS	3 PLACES MAX RELAX DROITE/GAUCHE	3 PLAZAS MAX RELAX DERECHO/IZQUIERDO
3 SEATER MAX WITH MECHANISM	3 POSTI MAX MECC	3 SITZER MAX MIT FUNKTION	3 PLACES MAX MECHANIQUE	3 PLAZAS MAX MECHANIQUE
CENTRAL ELEMENT	ELEMENTO CENTRALE	ZWISCHENELEMENT	ELEMENT CENTRAL	ELEMENTO CENTRAL
CENTRAL ELEMENT 2 SEATER	CENTRALE 2 POSTI	ZWISCHENELEMENT 2 SITZER	ELEMENT CENTRAL 2 PLACES	ELEMENTO CENTRAL 2 PLAZAS
END ELEMENT RIGHT/LEFT	TERMINALE DX/SX	ENDELEMENT RECHTS/LINKS	TERMINAL DROITE/GAUCHE	TERMINAL DERECHO/IZQUIERDO
END ELEMENT 2 SEATER RIGHT/LEFT	TERMINALE 2 POSTI DX/SX	ENDELEMENT 2 SITZER RECHTS/LINKS	TERMINAL 2 PLACES DROITE/GAUCHE	TERMINAL 2 PLAZAS DERECHO/IZQUIERDO
END ELEMENT 2 SEATER RELAX RIGHT/LEFT	TERMINALE 2 POSTI RELAX DX/SX	ENDELEMENT 2 SITZER OTTOMANE RECHTS/LINKS	TERMINAL 2 PLACES RELAX DROITE/GAUCHE	TERMINAL 2 PLAZAS RELAX DERECHO/IZQUIERDO
END ELEMENT 2 SEATER MOVABLE BACK	TERMINALE 2 POSTI SPALLIERA MECCANICA	ENDELEMENT 2 SITZER SPALLIERA MECCANICA	TERMINAL 2 PLACES DOSSIER AMOVIBLE	TERMINAL 2 PLAZAS CON MECANISMO
END ELEMENT 2 SEATER MOVABLE ARMREST	TERMINALE 2 POSTI BRACCIOLO MOVIBILE	ENDELEMENT 2 SITZER BRACCIOLO MOVIBILE	TERMINAL 2 PLACES ACCOUDOIR MOVIBILE	TERMINAL 2 PLAZAS APOYABRATOS MOVIBLE
END ELEMENT 2 SEATER WITH ORTHOPEDIC BED	TERMINALE 2 POSTI LETTO DX/SX	ENDELEMENT 2 SITZER LETTO RECHTS/LINKS	TERMINAL 2 PLACES LIT DROITE/GAUCHE	TERMINAL 2 PLAZAS CAMA DERECHO/IZQUIERDO
END ELEMENT RIGHT/LEFT SPEC. 45DEGR.	TERMINALE DX/SX 45°	ENDELEMENT RECHTS/LINKS 45°	TERMINAL DROITE/GAUCHE 45°	TERMINAL DROITE/GAUCHE 45°
END ELEMENT 3 SEATER RIGHT/LEFT	TERMINALE 3 POSTI DX/SX	ENDELEMENT 3 SITZER RECHTS/LINKS	TERMINAL 3 PLACES DROITE/GAUCHE	TERMINAL 3 PLAZAS DERECHO/IZQUIERDO
END ELEMENT 3 SEATER RIGHT/LEFT WITH ORTHOPEDIC BED	TERMINALE 3 POSTI DX/SX LETTO ORTOPEDICO	ENDELEMENT 3 SITZER RECHTS/LINKS MIT LATTENROSENBETT	TERMINAL 3 PLACES DROITE/GAUCHE LIT	TERMINAL 3 PLAZAS DERECHO/IZQUIERDO CAMA
CHAISE LONGUE RIGHT/LEFT	CHAISE LONGUE DX/SX	REKAMIERE RECHTS/LINKS	CHAISE LONGUE DROITE/GAUCHE	CHAISE LONGUE DERECHO/IZQUIERDO
CHAISE LONGUE RIGHT/LEFT WITH HEADREST	CHAISE LONGUE DX/SX POGGIATESTA	REKAMIERE RECHTS/LINKS KOPFSTUETZE	CHAISE LONGUE DROITE/GAUCHE APPUIS TETE	CHAISE LONGUE DERECHO/IZQUIERDO APOYACABEZA CHAISE
CHAISE LONGUE SQUARED RIGHT/LEFT	CHAISE LONGUE SQUADRATA DX/SX	REKAMIERE CARIERT RECHTS/LINKS	CHAISE LONGUE CARRÉ DROITE/GAUCHE	LONGUE CONTENEDOR DERECHO/IZQUIERDO
PENINSULA RIGHT/LEFT	PENISOLA DX/SX	PENINSEL RECHTS/LINKS	ILE DROITE/GAUCHE	PENINSULA DROITE/GAUCHE
CORNER	ANGOLO	ECKE	ANGLE	RINCON
SOUND CORNER	ANGOLO SOUND	ECKE SOUND	ANGLE SOUND	RINCON SOUND
CENTRAL SOUND STORAGE	CONTENITORE CENTRALE SOUND	ZWISCHENELEMENT SOUND MIT BEHAELTER	COFFRE ELEMENT CENTRAL SOUND	CONTENEDOR ELEMENTO CENTRAL SOUND
CORNER/TABLE	TAVOLO CORNER	TISCH/ECKE	ANGLE/TABLE	RINCON/MESA
CORNER NAPOLEON	ANGOLO NAPOLEON	NAPOLEON ECKE	ANGLE NAPOLEON	RINCON NAPOLEON
ROUND CORNER	ANGOLO ROUND	RUNDE ECKE	ANGLE ROUND	RINCON ROUND
MANUAL RECLINER	POLTRONA MECC MANUALE	TV SESSEL MANUELLE	FAUTEIL RECLINER MANUELLE	BUTACA RELAX CON FUNCION MANUAL
SOFABED	DIVANO LETTO	SOFABETT	RAPIDO	SOFACAMA
ORTHOPEDIC BED	LETTO ORTOPEDICO	LATTENROSENBETT	LIT	CAMA
ROLL CHAIR	POLTRONA ROLL	ROLL SESSEL	FAUTEIL PIVOTANT	BUTACA CON GIRATORIO
ROLL CHAIR WITH MECHANISM	POLTRONA ROLL MECCANISMO	ROLL SESSEL MIT FUNKTION	FAUTEIL ROLL MECANIQUE	BUTACA CON GIRATORIO Y MECANISMO
ROUND SEAT XXL	ROUND SEAT XXL	ROUND SEAT XXL	ROUND SEAT XXL	ROUND SEAT XXL
FOOTSTOOL	POUF	HOCKER	POUF	POUF
FOOTSTOOL RIGHT /LEFT	POUF DX/SX	HOCKER RECHTS/LINKS	POUF DROITE/GAUCHE	POUF DERECHO/IZQUIERDO
FOOTSTOOL MAX	POUF MAX	HOCKER MAX	POUF MAX	POUF MAX
DROP SHAPED FOOTSTOOL	POUF GOCCIA	HOCKER GOCCIA	POUF GOCCIA	POUF GOCCIA
CASE/ FOOTSTOOL	POUF CONTENITORE	HOCKER MIT BEHAELTER	POUF COFFRE	POUF CONTENEDOR
BACK CUSHIONS	CUSCINO SPALLIERA	RUECKEN KISSEN	COUSSIN DE DOSSIER	COJIN DE RESPALDO
HELP LUMBAR CUSHION	CUSCINO POGGIARENI	NIEREN KISSEN	COUSSIN CALEREIN	COJIN HELP
PILLOW 45X45	CUSCINO 45X45	KISSEN 45X45	COUSSIN 45X45	COJIN 45X45
HEADREST	POGGIATESTA	KOPFSTUETZE	APPUYE TETE	APOYACABEZA
RECTANGULAR TABLE	TAVOLO RETTANGOLARE	TISCH RECHTECKIG	TABLE RECTANGULAIRE	MESA RECTANGULAR
ROUND TABLE	TAVOLO TONDO	RUND TISCH	TABLE RONDE	TABLE REDONDA
OVAL TABLE	TAVOLO OVALE	OVAL TISCH	TABLE OVAL	TABLE OVAL
SIDE TABLE	TAVOLO LATERALE	BEISTELL TISCH	TABLE LATERAL	TABLE LATERAL

GENERAL SALES CONDITIONS AND TECHNICAL SPECIFICATIONS

The pictograms, weights, volumes and dimensions of the products indicated in the price list are purely indicative. The colours and sizes listed may not faithfully reproduce the real ones may not be the subject of any complaint.

All prices listed in this price list are intended for public retail sale and are valued in Euros. The prices indicated in this price list refer exclusively to STANDARD products.

An extra charge of minimum 3% and maximum 10% may be applied for extra ordinary type of productions.

Without any surcharge, seat cushions can be supplied in the following densities: soft, medium or firm. For the option Extra Comfort an additional charge of 50€ is requested for each seat cushion (with not visible inner springs), while for the option Traditional Springs 60€ per seat surcharge and 4 additional weeks are to be added to the standard delivery time. The options Extra Comfort and Traditional Springs are NOT available for every model in collection. Please ask for availability.

For those models which have wood without briar as standard feature it is possible to choose any colour from the NIERI wood swatch except the real briar wood. With an additional surcharge of 5% it is also possible to have a briar polishing or to choose a RAL colour or another colour on the basis of a customer's sample.

For those models which have wood with briar as standard feature it is possible to order the version without briar in a colour from the NIERI wood swatch, a RAL colour

or another colour on the basis of a customer's sample, always through an additional charge of 5%.

The whole NIERI range can be upholstered with leather or fabric provided from the customer, whenever agreed by our management. In this case, the price has to be calculated in Category A fabrics. Please, be advised that the quantity of coverings mentioned in this listing are to be intended in squared meters of leather not considering the defected parts, and in linear meters of 140 cm high fabric-rolls not considering the ratio of the picture (e.g. in case of stripes or a peculiar pattern a larger quantity of fabric has to be considered).

Excluding exceptionally busy periods or holidays breaks the average delivery term for our STANDARD products varies from eight to ten weeks. For NON STANDARD products or special production (such as briar removing, traditional springs, customer coverings or wood samples and visible changes to the standard models) from 2 to 4 weeks may be added to the normal delivery time. The exact time will be stated in our written confirmation. Please always carefully check it and timely report unclear issues.

Roma Imperiale has the right to make changes without notice. The information contained in this publication are not binding. Some product might go out of production from one publication to the other so please always ask for product availability.

PRODUCT INFORMATION

The structure is made of solid wood

The product is assembled using glue and interlocking joints

All our materials comply with European standards

The seat support is sustained by elastic belts

The filling and Dacron are CFC-free

The leather upholstery is PCP-free

The packaging is recyclable

The bed function changes the design of the sofa

LIGHT PADDING FURNITURE PRODUCTS

Upholstered furniture with international flair and style mainly has "light padding". It expresses casual elegance and comfortable, cosy seating. When new this upholstery appears relatively smooth, in use it becomes soft and snug and most enjoyable. Most of the Nieri upholstered furniture are manufactured according to modern criteria with "light padding". If you have chosen cushions of a down feather-type or with a Dacron soft inlay we would like to remind you that the content of the cushions is distributed equally into individual chambers. The formation of waves and hollows in usage is not a sign of low quality but of its natural and genuine materials and expert crafting.

According to intensify of use especially in the area of the "favourite seating place" regular shaking or plumping may be necessary. Claims for such a natural feature such as "light padding" will not be accepted.

MAINTANANCE INSTRUCTIONS FOR CLEANING AND CARE

Leather furniture might be compared with the car of your body. How you use and take care of your upholstered furniture is therefore essential for its appearance and life expectancy. Experience shows that the lighter and more natural the type of cover material the more sensitive it is to outer influences.

Please observe at all time the following care instructions:

- Never treat leather with solvents of any kind (e.g. turpentine, stain remover, cleaning paraffin, shoe polish, floor polish or any type of detergent). Please follow our recommended instructions as otherwise any claims under guarantee may become invalid.
- Any kind of stain must be removed immediately and in the proper way. Pay attention not to use in an improper way any cloths, detergents, chemical or mechanical products that could cause irreparable damages. It's important to distinguish the type of stain:

- OILY stains (e.g. oil, chocolate, mayonnaise): use blotting-paper to absorb and remove the oil substance from the surface. Clean with a damp cloth, not abrasive, soaked in water and neutral soap and then dry gently with another clean cloth.

- SOLUBLE stain (e.g. Coffee, tea, milk): use a clean cloth, not abrasive, soaked in water and neutral soap. Remove the soluble substance and dry with another clean cloth.

- DRY stains: first of all don't rub the dirty part. Take a soft brush and brush very gently.

For any other specific questions in the field of leather cleaning and leather care please contact directly our partner:

LCK Leather Care Keller GmbH

Im Unterfeld 2, D-76698 Ubstadt-Weiher, Germany

Phone: (49) 7251 9625 0 · Fax: (49) 7251 9625 29 · E-mail: info@lck-international.com - www.lederpflege.de

- The prices in the pricelist are valid until December 31st 2011. Roma Imperiale reserves the right to make changes to the prices without prior notification if this becomes necessary as a result of rising purchase or production costs.

- The product warranty and care and maintenance instructions are described on the Guarantee and Quality certificate.

ALLGEMEINE VERKAUFSBEDINGUNGEN UND TECHNISCHE ANGABEN

Die Bildsymbole und Maße (Gewichte, Volumen und Größen), der in dieser Liste aufgeführten Produkte, sind rein indikativ. Es ist möglich, dass die aufgeführten Farben und Größen nicht exakt den tatsächlichen entsprechen, Beanstandungen diesbezüglich werden nicht akzeptiert.

Die in der vorliegenden Verkaufsliste aufgeführten unverbindlichen Preisempfehlungen sind in Euro angegeben.

Die in der vorliegenden Liste aufgeführten Preise beziehen sich ausschließlich auf STANDARD-Produkte. Für Sonderfertigungen kann ein Aufpreis von mindestens 3% und höchstens 10% berechnet werden.

Die Kissen der Verkaufslistenprodukte sind ohne Aufpreis in verschiedenen Härtevarianten lieferbar: soft, medium, hart. Für jede Sitzeinheit „Extra Comfort“ (mit internem, unsichtbarem Federkern) wird ein Aufpreis in Höhe von 50€ berechnet, während für eine traditionelle Federung der Sitze 60€ Aufpreis pro Sitzeinheit und vier Wochen zusätzlich zur normalen Lieferzeit für die Herstellung berechnet werden. Sowohl die Versionen Extra Comfort als die traditionelle Federung sind nicht für alle Modelle erhältlich. Bitte erkundigen Sie sich über die Machbarkeit.

Für die Modelle mit dem Standardprofil aus Holz ohne Wurzelholz ist jede NIERI Farbwahl, außer Wurzelholz, möglich. Gegen 5% Aufpreis hingegen sind eine wurzelholzimitierende Lackierung, RAL- Farben, bzw. vom Kunden vorgegebene Farbmuster umsetzbar.

Für die Modelle mit dem Standardprofil aus Holz mit Wurzelholz kann die Version gegen einen Aufpreis von 5% ohne Wurzelholz und in den Farben NIERI, RAL oder nach einem vom Kunden vorgegebenen Farbmuster angefordert werden.

Die gesamte Serie NIERI kann mit einem, direkt vom Kunden gelieferten, Überzug nach vorheriger technischer Genehmigung des Betriebes realisiert werden. In diesem Fall bezieht sich der Referenzpreis auf den des Produktes aus Stoff der Kategorie A. Die vom Kunden angeforderten Mengen werden für Leder in Quadratmetern berechnet.

Bitte beachten Sie, dass die angegebenen Mengen für einwandfreies Leder ohne Verschnitt und für Stoffe ohne Muster mit einer Höhe von 140 cm in Metern gelten. Für gemusterten Stoff muss entsprechend mehr berechnet werden.

Von Störungsfällen in der Herstellung oder Ferienschlusszeiten abgesehen, liegt die durchschnittliche Lieferzeit der STANDARD-Produkte bei acht bis zehn Wochen. Für Sonderanfertigungen (wie z. B. Wurzelholzentfernung, traditionelle Federung, Lackierung nach Kundenmuster oder sichtbare Veränderungen an Standardprodukten) kann sich die normale Lieferzeit um zwei bis vier Wochen verlängern. Der vorgesehene Liefertermin ist in jedem Fall auf der Auftragsbestätigung angegeben. Bitte prüfen Sie die Auftragsbestätigung sorgfältig und teilen Sie uns eventuelle Fehler oder Ungereimtheiten innerhalb von zwei Wochen mit.

Roma Imperiale behält sich vor, Änderungen auch ohne vorherige Kommunikation vornehmen zu können. Die Informationen in dieser Liste sind nicht verbindlich. Es kann vorkommen, dass Produkte von einer Veröffentlichung zur anderen nicht mehr hergestellt werden. Fragen Sie deshalb immer nach der Verfügbarkeit. Danke.

PRODUKTHINWEISE

Das Gestell besteht aus einer Massivholzkonstruktion.

Der Zusammenbau des Produktes erfolgt durch Verleimung und Steckverbindungen.

All unsere Materialien entsprechen den europäischen Bestimmungen.

Die Sitzunterfederung besteht aus elastischen Riemen.

Polsterung und Dacron sind CFC- frei.

Lederüberzüge sind PCP- frei.

Recyclebare Verpackung.

Die Bettfunktion kann das Aussehen und das Design der Garnitur ändern.

PRODUKTE MIT LEGERER POLSTERUNG

Polstermöbel mit internationalem Flair und Stil haben größtenteils eine „legere Polsterung“. Diese steht für informelle Eleganz und einen bequemen, gemütlichen Sitzkomfort. In neuem Zustand haben diese Polstermöbel ein recht glattes Erscheinungsbild, was sich im Laufe der Nutzung ändert in ein weiches, kuscheliges und Nest, in welchem man die Zeit genießen kann. Die meisten Nieri Polstermöbel sind leger gepolstert. Falls Sie ein Modell mit Daunens- oder Dacron-Inlet gewählt haben, möchten wir Sie daran erinnern, dass der Kisseninhalt gleichmäßig in abgeschlossenen Kammern verteilt ist. Das Entstehen von Wellen und Mulden während der Nutzung ist nicht Zeichen minderer Qualität sondern zeugt von der Echtheit und Natürlichkeit der verwendeten Materialien und von ausgereifter Handwerkskunst. Im Zuge intensiver Nutzung, wie es z. B. beim Lieblingsplatz der Fall ist, möchten wir darauf hinweisen, dass es notwendig ist, die Kissen regelmäßig aufzuschütteln und zurechtzustreichen.

Beanstandungen, die auf die natürlichen Eigenschaften von legerer Polsterung zurückzuführen sind werden nicht anerkannt.

PFLEGE- UND REINIGUNGSHINWEISE

Ledermöbel lassen sich sehr gut mit der menschlichen Haut vergleichen. Wie Sie Ihr Ledermöbel nutzen und pflegen ist demnach entscheidend für dessen Aussehen und Lebensdauer. Die Erfahrung besagt, dass je leichter und natürlicher das Bezugsmaterial ist, desto sensibler reagiert es auf äußere Einflüsse. Bitte befolgen Sie immer die von uns empfohlenen Pflegehinweise, da andernfalls die Garantie verfällt.

Bitte berücksichtigen Sie immer folgende Pflegehinweise:

- Behandeln Sie Leder nie mit Lösungsmitteln aller Art (z. B. Terpentin, Fleckentferner, Waschbenzin, Schuhcreme, Boden- bzw. jegliches anderes aggressives Reinigungsmittel).
- Jeder Fleck muss umgehend und fachgerecht entfernt werden. Bitte achten Sie darauf keine ungeeigneten chemischen oder mechanischen Mittel wie Scheuerlappen oder Reiniger zu verwenden.

Generell muss zwischen zwei Arten von Flecken unterschieden werden:

Fettflecken (z.B. Öl, Schokolade, Mayonese...): benutzen Sie Löschpapier um die fettige Substanz aufzunehmen. Tupfen Sie mit einem feuchten, eventuell mit pH-neutraler Seife versetzten, weichen Tuch die Stelle ab und trocknen Sie sie dann mit einem sauberen Tuch. Wasserlösliche Flecken (z. B. Kaffee, Tee, Milch): Tupfen Sie mit einem feuchten, eventuell mit pH-neutraler Seife versetzten, weichen Tuch die Stelle ab und trocknen Sie sie dann mit einem sauberen Tuch. Getrocknete Flecken bitte nie abrubbeln. Nehmen Sie eine weiche Bürste und bürsten Sie sehr sanft.

Für weitere Informationen und Details bezüglich der Pflege und Reinigung unserer Überzüge bitten wir Sie, Ihre Anfragen direkt an unseren Partner zu stellen:

LCK Leather Care Keller GmbH

Im Unterfeld 2, D-76698 Ubstadt-Weiher, Germany

Phone: (49) 7251 9625 0 · Fax: (49) 7251 9625 29 ·

E-mail: info@lck-international.com · www.lederpflege.de

- Die Preise der vorliegenden Liste sind bis zum 31. Dezember 2011 gültig. Roma Imperiale behält sich vor, Preisveränderungen ohne Vorankündigung vorzunehmen, falls es die Erwerbs- oder Produktionskostenentwicklung erfordern.

- Die Garantie, sowie Pflege- und Wartungshinweise des Produktes sind im Garantie- und Qualitätszertifikat beschrieben

CREDITS :

PH: Chiara Daniele

GRAPHIC DESIGN: Chiara Daniele

PRINTING: Grafiche dell'Artiere srl

Ottobre 2013

NIERI is a trademark of ROMA IMPERIALE srl

via Bologna, 13 - 51039 - Quarrata - PT- ITALY

tel: 0039 0573 7733 - fax: 0039 0573 739710

www.romaimperiale.net

info@nieri.it